

# LN Series Free Programmable Controllers

## Product Bulletin

LN-PRG203-1, LN-PRG300-1, LN-PRG4x0-1, LN-PRG5x0-1

**Code No. LIT-12011317**  
**Software Release 4.1**  
**Issued October 6, 2008**  
*Supersedes November 9, 2007*

The LN Series Free Programmable Controllers are microprocessor based free programmable controllers, designed to control various Heating, Ventilating, and Air Conditioning (HVAC) applications.

The Metasys® system LN Series Free Programmable controllers product family is built to meet rigorous quality standards. The complete family of Metasys system LN Series controllers is designed for use with any LONWORKS® network open and interoperable system.



**Figure 1: LN-PRG500-1 Controller**

**Table 1: Features and Benefits**

Features	Benefits
<b>Configurable Software</b>	Features an LNS® plug-in that provides the ability to easily configure inputs, outputs, and sequence options. Configured device complies with LONMARK® Space Comfort Control (SCC) profile for interoperability with other LONMARK devices. Also features more than 60 network variables.
<b>Robust Hardware</b>	Features a fire retardant plastic enclosure, a 128k Flash memory for the configuration and trending of up to 12,000 events, and a status indicator on each output.
<b>Powerful Control Options</b>	Allow you to easily configure all features, including, input types, output types, heating and cooling stages, variable airflow, and Proportional plus Integral plus Derivative (PID) loops. The controller supports four input types: space temperature; setpoint adjustment; duct temperature; and occupancy bypass, or window contacts.

## **LN Series Free Programmable Controllers Overview**

You can control equipment such as roof top units, fan coils, heat pumps, ventilator units, and terminal units with the LN Series Free Programmable Controllers (Figure 1). The LN Series Free Programmable Controller line can be programmed using the LN-Free Programming Plug-in or the LN Graphical Programming Interface (GPI) Plug-in with LN-Builder 3.2 software.

### ***LNS LN-Free Programming Plug-in***

The LN-Free Programming Plug-in tool is unique in the controls industry because it combines a user-friendly Graphical User Interface (GUI) with the power and flexibility of a code editor and compiler. The LN-Free Programming Plug-in tool uses a simplified version of BASIC that is custom made to suit control requirements.

### ***LNS LN Graphical Programming Interface (GPI) Plug-in***

The LN Graphical Programming Interface Plug-in tool is a programming tool that allows for the building of control sequences by dragging and dropping block objects and then linking the objects with a simple click, select, and release. With a user-friendly interface and intuitive programming environment, GPI makes Heating, Ventilating, and Air Conditioning (HVAC) programming easier than ever.

### ***LNS LN-Scheduler Plug-in***

The LN-Scheduler plug-in allows you to easily configure a weekly based schedule and a special day schedule for holidays. Easily add and remove the special day event into the calendar by a simple click of the mouse.

### **Dimensions**

Figure 2 shows the dimensions for the LN-PRG203-1 and LN-PRG300-1 controllers.

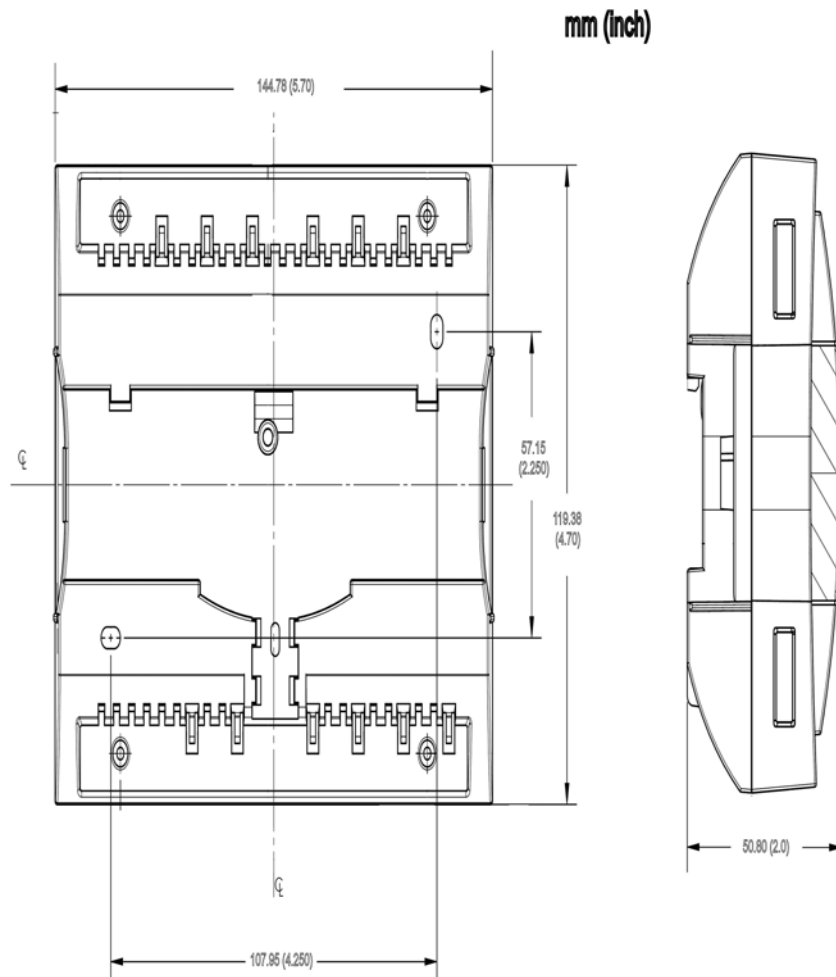

**Figure 2: LN-PRG203-1 and LN-PRG300-1 Dimensions**

Figure 3 shows the dimensions for the LN-PRG4x0-1 and LN-PRG5x1-0 controllers.

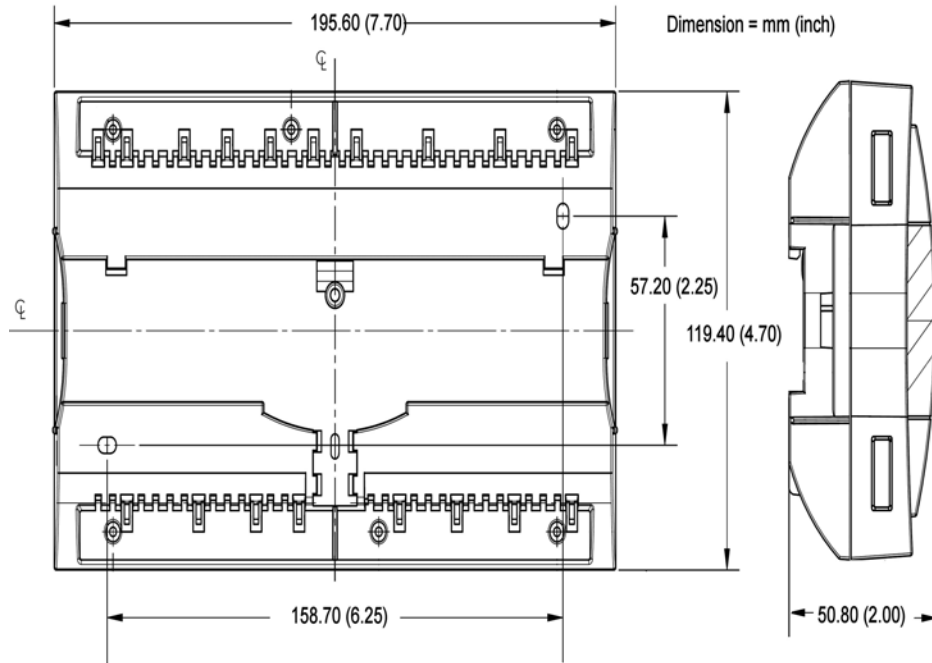

**Figure 3: LN-PRG4x0-1 and LN-PRG5x0-1 Dimensions**

# LONMARK Objects and Network Variables

## LN-Free Programming Plug-in

The following figures show the LONMARK Objects and Network Variables for the LN Free Programmable Controllers when you use the LNS LN-Free Programming Plug-in.

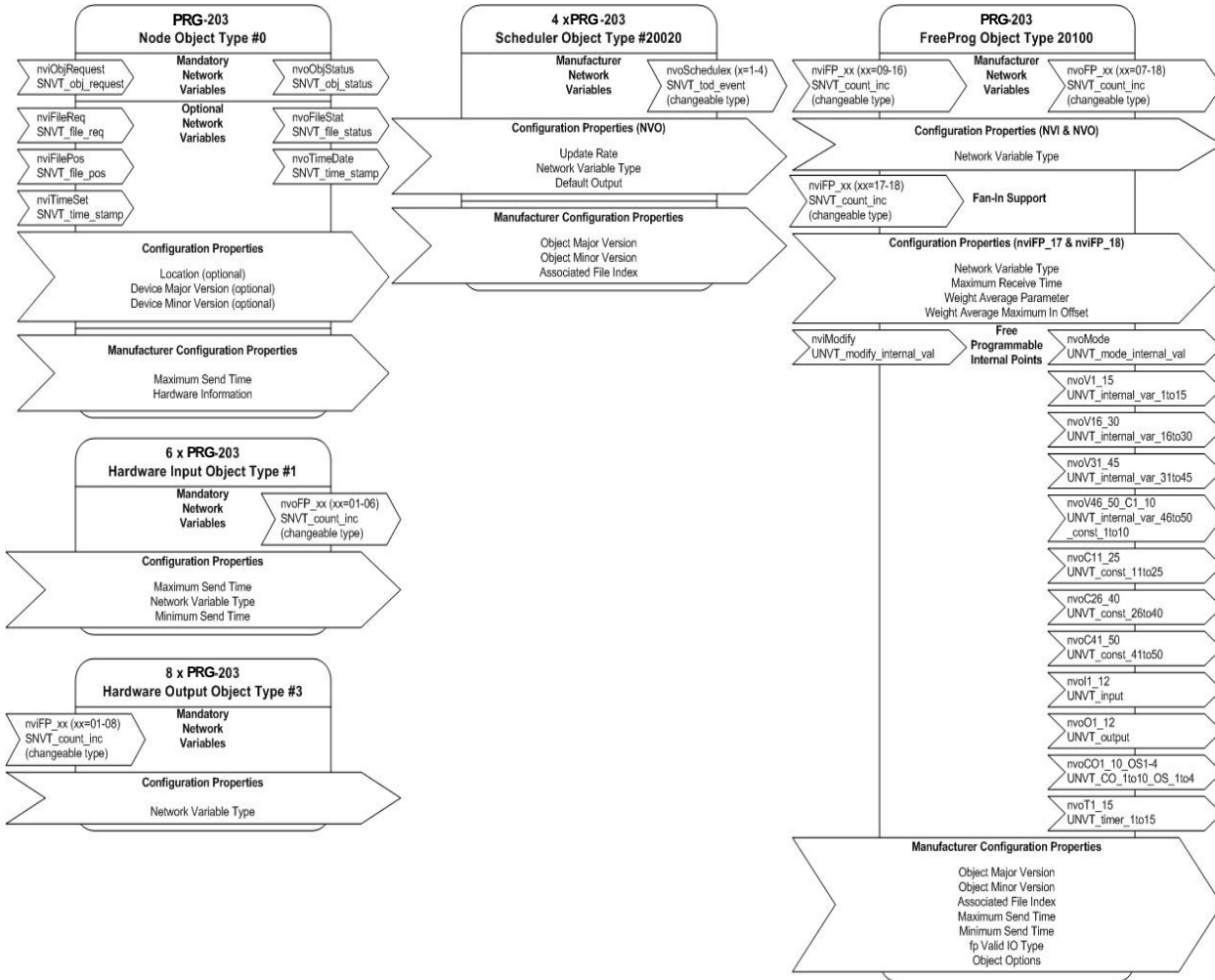

Figure 4: LN-Free Programming Plug-in LONMARK Objects and Network Variables - LN-PRG203-1

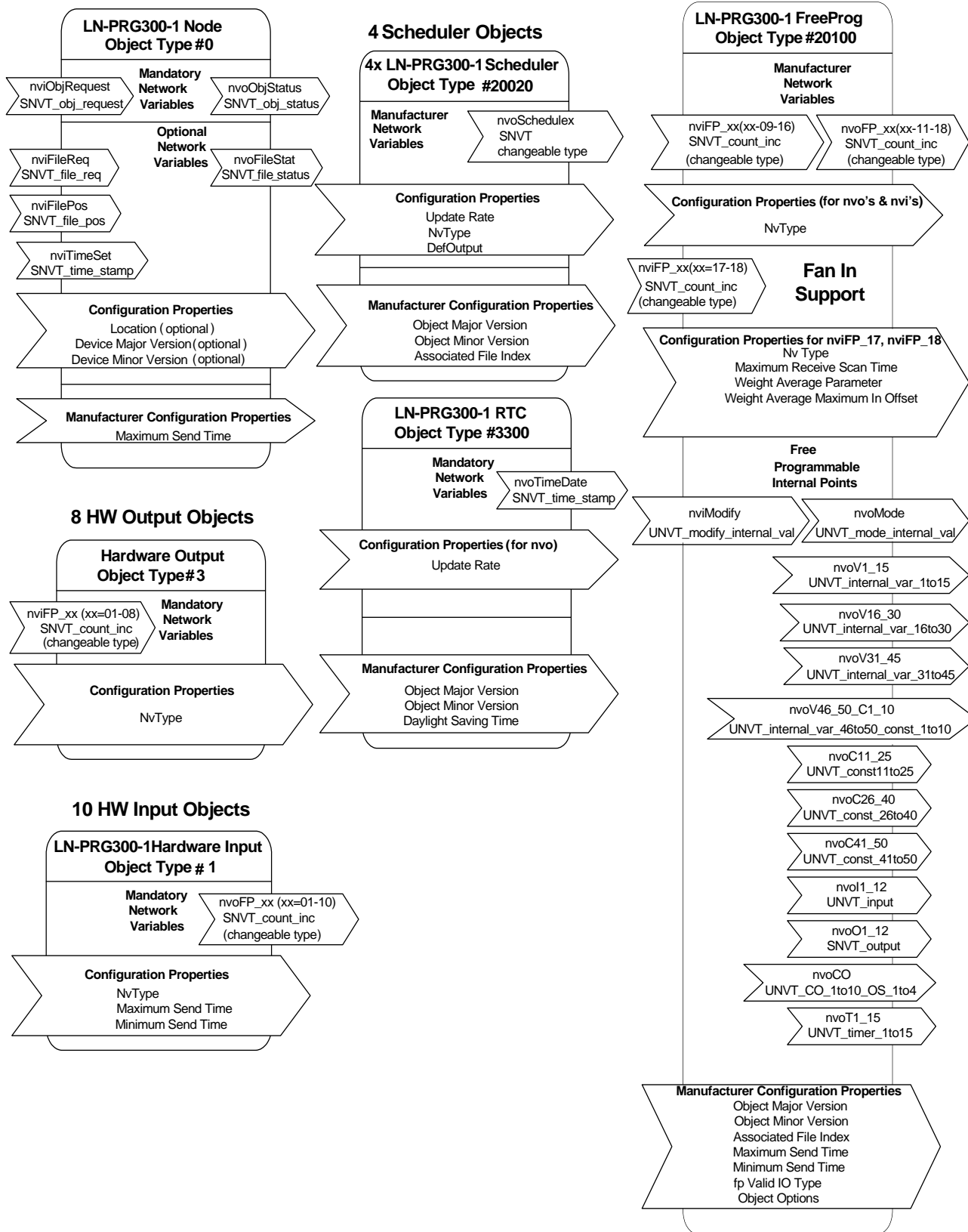

Figure 5: LN-Free Programming Plug-in LONMARK Objects and Network Variables - LN-PRG300-1

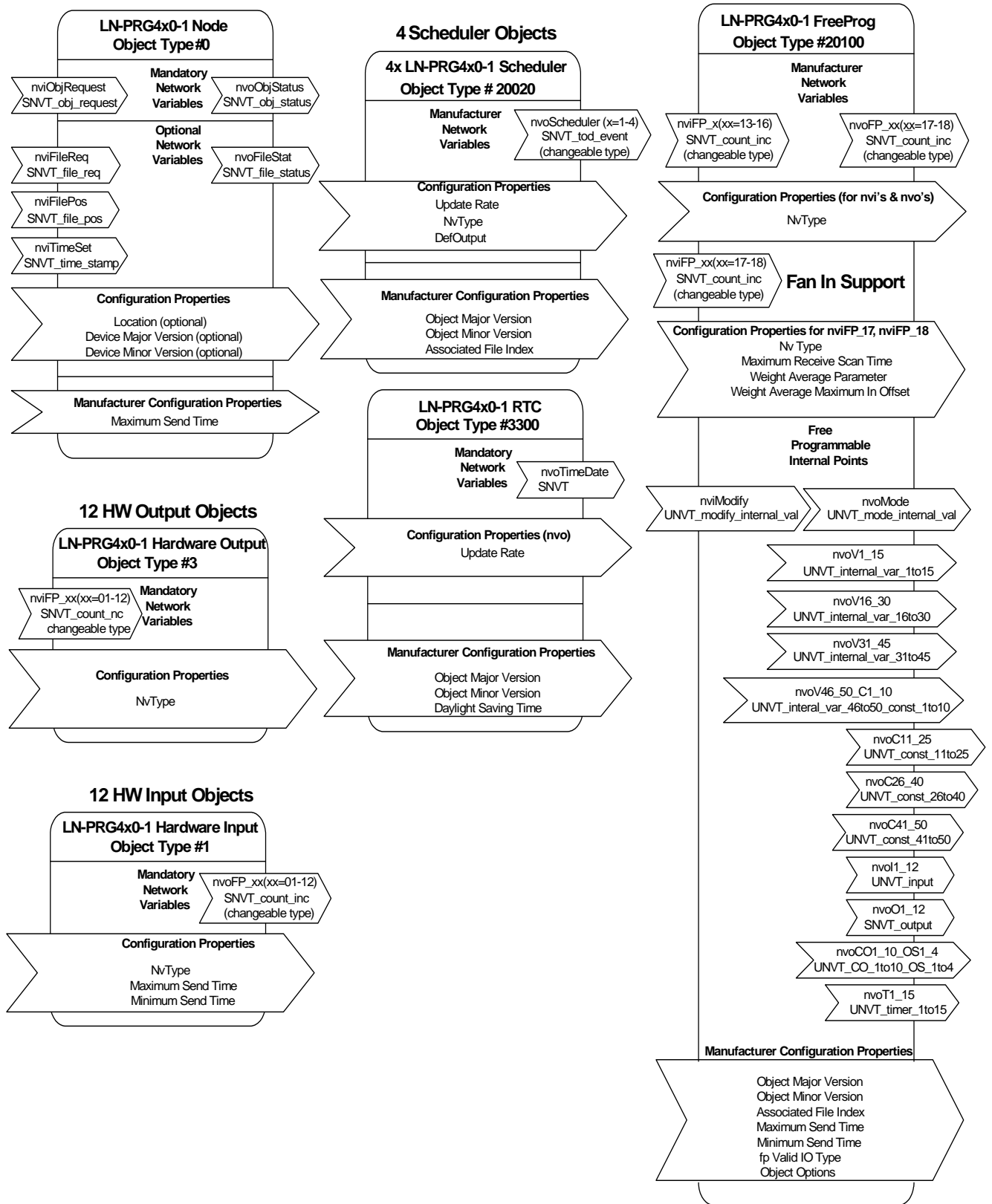

Figure 6: LN-Free Programming Plug-in LonMARK Objects and Network Variables - LN-PRG4x0-1

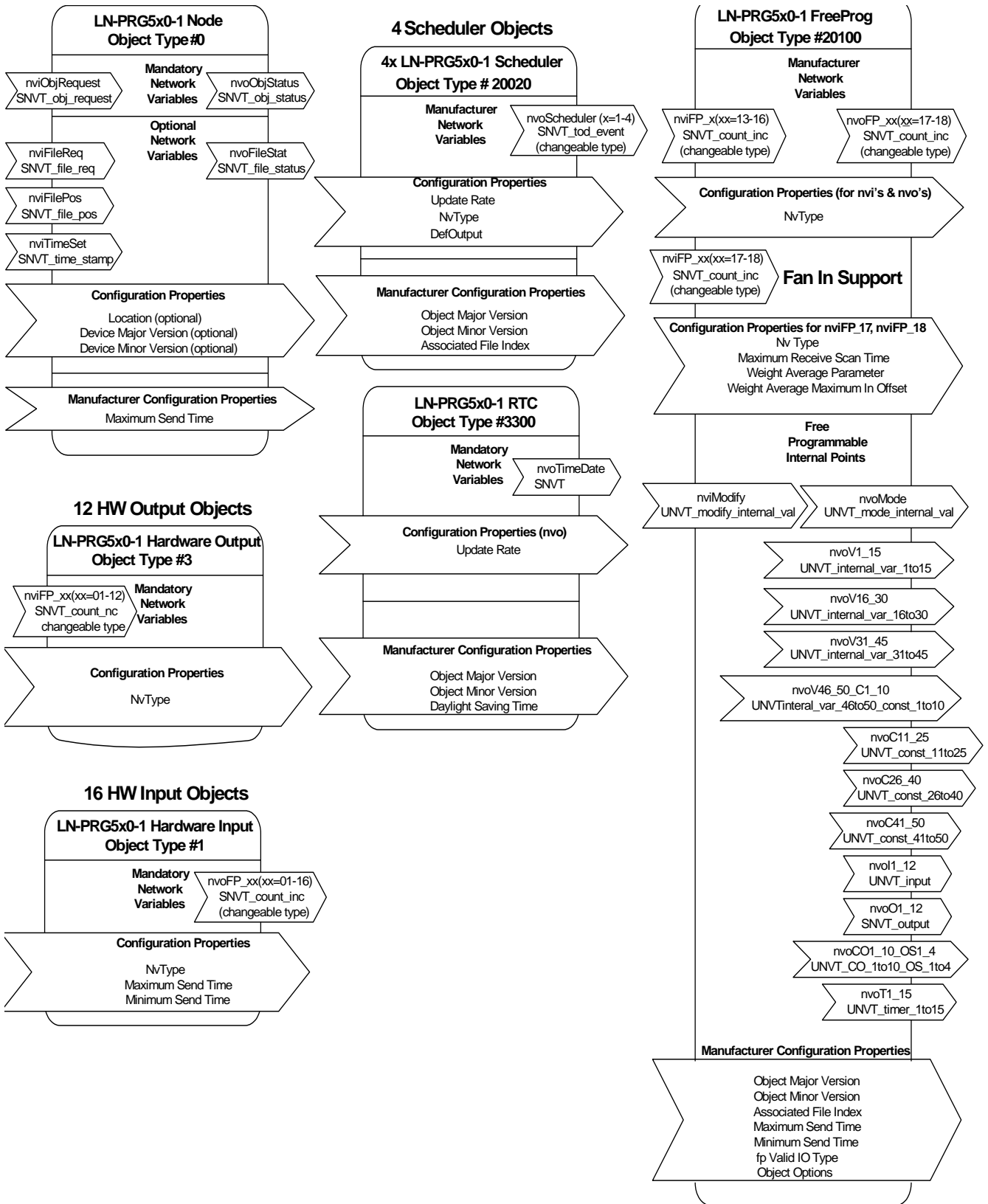

Figure 7: LN-Free Programming Plug-in LONMARK Objects and Network Variables--LN-PRG5x0-1



## LN GPI

The following figures show the LONMARK Objects and Network Variables for the LN Free Programmable Controllers when you use GPI.

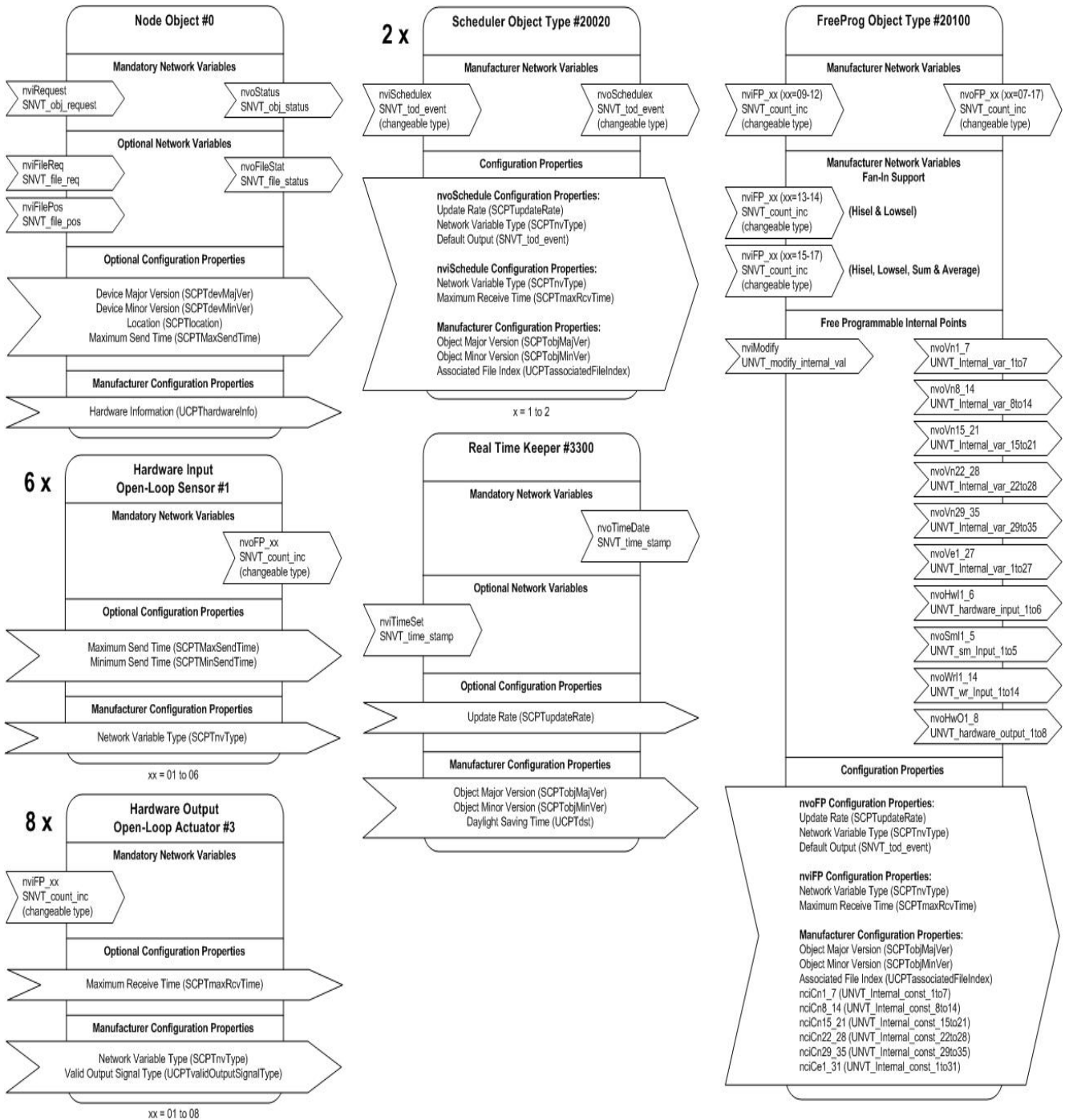

Figure 8: GPI LONMARK Objects and Network Variables - LN-PRG203-1

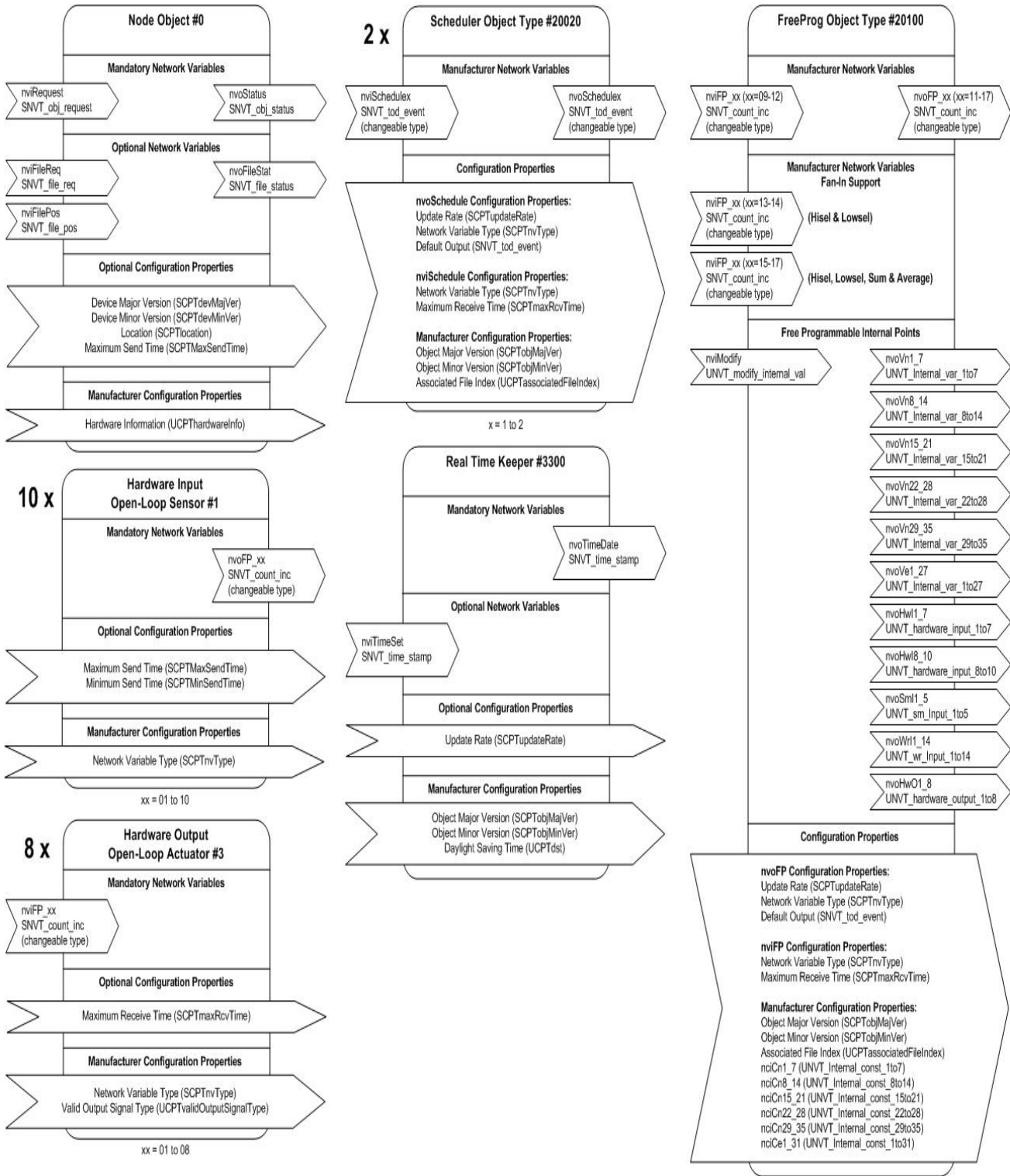

Figure 9: GPI LONMARK Objects and Network Variables - LN-PRG300-1

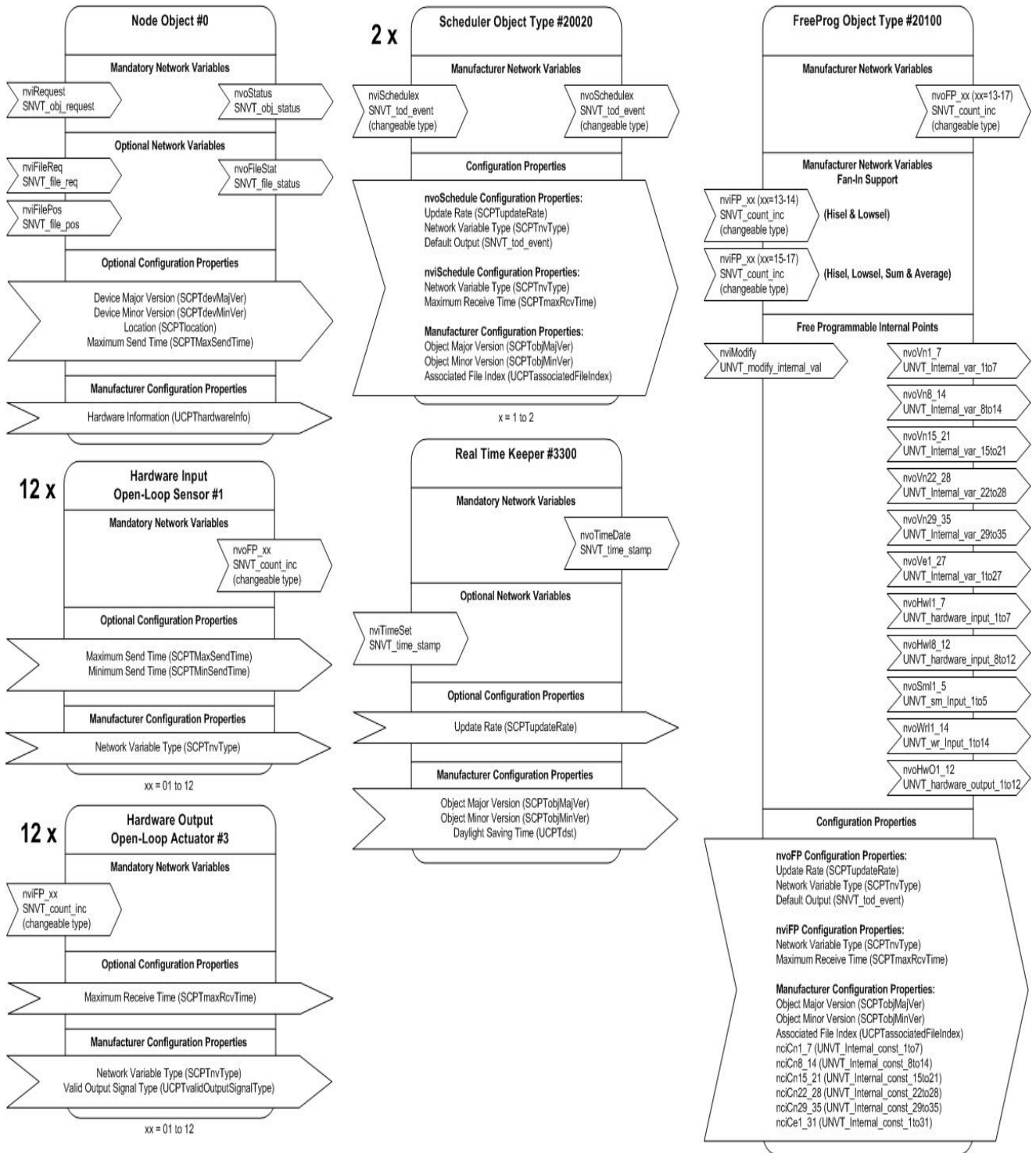

Figure 10: GPI LonMark Objects and Network Variables - LN-PRG4x0-1

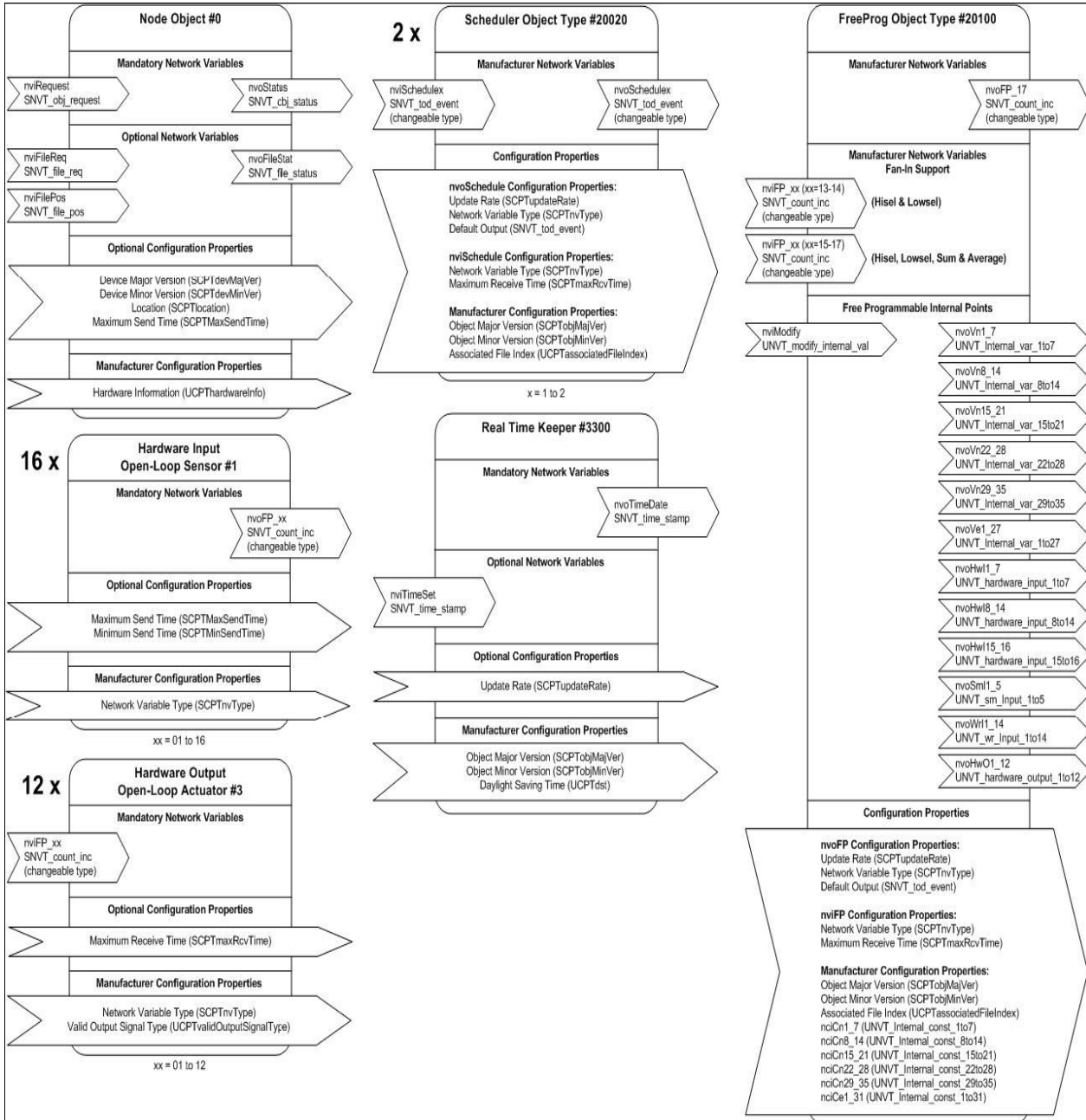

Figure 11: GPI LONMARK Objects and Network Variables--LN-PRG5x0-1

**Technical Specifications**  
**LN-PRG203-1 (Part 1 of 2)**

<b>Product Code</b>	LN-PRG203-1
<b>Power Requirement</b>	Voltage: 24 VAC/DC; $\pm 15\%$ , 50/60 Hz, Class 2 Protection: 1.85 A auto-reset fuse Consumption: 5 VA Maximum Consumption: 18 VA
<b>Ambient Storage Conditions</b>	Ambient Operating Temperature: 0 to 70°C, (32 to 158°F) Ambient Storage Temperature: -20 to 70°C, (-4 to 158°F) Ambient Relative Humidity: 0 to 90% noncondensing
<b>General</b>	Processor: Neuron® 3150®, 8 bits, 10 MHz Memory: Nonvolatile Flash 64k (APB application); Nonvolatile Flash 128K (storage) Media Channel: TP/FT-10; 78 Kbps Communication: LonTalk® protocol Status Indicator: Green LED - power status and LON TX, Orange LED - service and LON RX Communication Jack: LON audio jack mono 1/8 in (3.5 mm)
<b>Enclosure</b>	Material: ABS type PA-765A Dimensions (with screws): 5.7 x 4.7 x 2.0 in. (144.8 x 119.4 x 50.8 mm) Shipping Weight: 0.97 lb (0.44 kg)
<b>Electromagnetic Compatibility</b>	CE Emission: EN55022: 1998 class B (conducted and radiated) CE Immunity: EN61000-4-2:1995, level 3 in air EN61000-4-2: 1995, level 2 by contact EN61000-4-3: 1996, level 2 EN61000-4-4: 1995, level 2 EN61000-4-6: 1996, level 2 ENV 50204: 1995, level 2
<b>Agency</b>	UL Listed: UL916 Energy management equipment Material: UL94-5VA
<b>Inputs</b>	Quantity: 6 universal software configurable Input Types: Digital: Dry Contact Pulse: Dry Contact Voltage: 0 to 10 VDC, Current: 0 to 20 mA with 249 ohms external resistor (wired in parallel), Accuracy: $\pm 0.5\%$ Resistor Support: Thermistor: Type 2 and Type 3 10k ohms Range: -40 to 150°C, (-40 to 302°F) Platinum: PT1000 1k ohm Range: -40 to 150°C, (-40 to 302°F) PT100: 100 ohms Range: -40 to 135°C, (-40 to 275°F) Potentiometer: Translation table configurable on several points, Accuracy: $\pm 0.5\%$ Input Resolution: 16-bit analog/digital converter

**LN-PRG203-1 (Part 2 of 2)**

<b>Outputs</b>	<p>Quantity: 8</p> <p>5 Digital: 24 VAC Triac, digital (on/off) or PWM 0.75 A @ 70°C; 158°F 1A @ 40°C; 104°F PWM control: adjustable period from 2 seconds to 15 minutes</p> <p>3 Universal: 0-10 VDC, digital 0-12 VDC (on/off) or PWM PWM control: adjustable period from 2 seconds to 15 minutes 20 mA maximum @ 12 VDC (60°C; 140°F) Auto reset fuse Maximum load 600 ohms Output Resolution: 10-bit digital/analog converter</p>
----------------	---

**LN-PRG300-1 (Part 1 of 2)**

<b>Product Code</b>	LN-PRG300-1
<b>Power Requirement</b>	<p>Voltage: 24 VAC/DC; ±15%, 50/60 Hz, Class 2</p> <p>Protection: 1.85 A auto-reset fuse</p> <p>Consumption: 5 VA</p> <p>Maximum Consumption: 18 VA</p>
<b>Ambient Storage Conditions</b>	<p>Ambient Operating Temperature: 0 to 70°C, (32 to 158°F)</p> <p>Ambient Storage Temperature: -20 to 70°C, (-4 to 158°F)</p> <p>Ambient Relative Humidity: 0 to 90% noncondensing</p>
<b>General</b>	<p>Standard: LONMARK Functional Profile: SCC-VAV Controller #8502</p> <p>Processor: Neuron 3150, 8 bits, 10 MHz</p> <p>Memory: Nonvolatile Flash 64k (APB application), Nonvolatile Flash 128k (storage)</p> <p>Media Channel: TP/FT-10; 78 Kbps</p> <p>Communication: LonTalk protocol</p> <p>Clock: Real-time clock chip, CR2032 lithium battery (for clock)</p> <p>Status Indicator: Green LED - power status and LON TX, Orange LED - service and LON RX</p> <p>Communication Jack: LON audio jack mono 1/8 in (3.5 mm)</p>
<b>Enclosure</b>	<p>Material: ABS type PA-765-A</p> <p>Dimensions: 5.7 x 4.7 x 2.0 in. (144.8 x 119.4 x 50.8 mm)</p> <p>Shipping Weight: 0.86 lb (0.39 kg)</p>
<b>Agency</b>	<p>UL Listed: UL916 Energy management equipment</p> <p>Material: UL94-5VA</p>
<b>Electromagnetic Compatibility</b>	<p>CE Emission: EN55022: 1998 class B (conducted and radiated)</p> <p>CE Immunity: EN61000-4-2:1995, level 3 in air EN61000-4-2: 1995, level 2 by contact EN61000-4-3: 1996, level 2 EN61000-4-4: 1995, level 2 EN61000-4-6: 1996, level 2 ENV 50204: 1995, level 2</p>

### LN-PRG300-1 (Part 2 of 2)

<b>Inputs</b>	Quantity: 10 universal software configurable Input Types: Digital: Dry Contact Pulse: Dry Contact Analog Voltage: 0 to 10 VDC, Accuracy: $\pm 0.5\%$ , Analog current: 4 to 20 mA with 249 ohms external resistor (wired in parallel), Accuracy: $\pm 0.5\%$ Resistor Support: Thermistor: Type 2, Type 3 10k ohms Range: -40 to 150°C, (-40 to 302°F) Accuracy: $\pm 0.5^\circ\text{C}$ , $\pm 0.9^\circ\text{F}$ Platinum: RTD 1k ohm Range: -40 to 150°C, (-40 to 302°F) Accuracy: $\pm 1.0^\circ\text{C}$ , $\pm 1.8^\circ\text{F}$ , PT100: 100 ohms Range: -40 to 135°C, (-40 to 275°F) Accuracy: $\pm 1.0^\circ\text{C}$ , $\pm 1.8^\circ\text{F}$ Resolution: 0.1°C to 0.18°F (10k ohms to 100k ohms supported using translation table) Potentiometer: Translation table configurable on several points, Accuracy: $\pm 0.5\%$ Accuracy $\pm 0.3\%$ full scale Input Resolution: 16-bit analog/digital converter
<b>Outputs</b>	Quantity: 8 (software configurable) 0 to 10 VDC, digital 0 to 12 VDC (on/off) or PWM PWM output: adjustable period from 2 seconds to 15 minutes 60 mA maximum @ 12 VDC (60°C; 140°F) maximum load 200 ohms Auto-reset fuse: 60 mA @60°C; 140°F, 100 mA @20°C; 68°F Output Resolution: 10-bit digital/analog converter

### LN-PRG410-1 and LN-PRG400-1 (Part 1 of 2)

<b>Product Codes</b>	LN-PRG410-1 and LN-PRG400-1
<b>Power Requirement</b>	Voltage: 24 VAC/DC; $\pm 15\%$ , 50/60 Hz, Class 2 Protection: 2.5 A auto-reset fuse Consumption: 5 VA Maximum Consumption: 18 VA Power Supply: 15 VDC output used to power 4 to 20 mA inputs
<b>Ambient Storage Conditions</b>	Ambient Operating Temperature: 0 to 70°C, (32 to 158°F) Ambient Storage Temperature: -20 to 70°C, (-4 to 158°F) Ambient Relative Humidity: 0 to 90% noncondensing
<b>General</b>	Standard: LONMARK Functional Profile: SCC-VAV Controller #8502 Processor: Neuron 3150, 8 bits, 10 MHz Memory: Nonvolatile Flash 64k (APB application), Nonvolatile Flash 128k (storage) Media Channel: TP/FT-10; 78 Kbps Communication: LonTalk protocol Clock: Real-time clock chip, CR2032 lithium battery (for clock) Status Indicator: Green LED - power status and LON TX, Orange LED - service and LON RX Communication Jack: LON audio jack mono 1/8 in (3.5 mm)
<b>Enclosure</b>	Material: ABS type PA-765A Dimensions (with screws): 7.7 x 4.7 x 2.0 in. (195.6 x 119.4 x 50.8 mm) Shipping Weight: 0.86 lb (0.39 kg)

**LN-PRG410-1 and LN-PRG400-1 (Part 2 of 2)**

<b>Agency</b>	UL Listed: UL916 Energy management equipment Material: UL94-5VA
<b>Electromagnetic Compatibility</b>	CE Emission: EN55022: 1998 class B (conducted and radiated) CE Immunity: EN61000-4-2:1995, level 3 in air EN61000-4-2: 1995, level 2 by contact EN61000-4-3: 1996, level 2 EN61000-4-4: 1995, level 2 EN61000-4-6: 1996, level 2 ENV 50204: 1995, level 2
<b>Inputs</b>	Quantity: 12 universal software configurable Input Types: Digital: Dry Contact Pulse: Dry Contact Analog Voltage: 0 to 10 VDC, Accuracy: $\pm 0.5\%$ , Analog current: 4 to 20 mA with 249 ohms external resistor (wired in parallel), Accuracy: $\pm 0.5\%$ Resistor Support: Thermistor: Type 2, Type 3 10k ohms Range: -40 to 150°C, (-40 to 302°F) Accuracy: $\pm 0.5^\circ\text{C}$ , $\pm 0.9^\circ\text{F}$ Platinum: RTD 1k ohm Range: -40 to 150°C, (-40 to 302°F) Accuracy: $\pm 1.0^\circ\text{C}$ , $\pm 1.8^\circ\text{F}$ , PT100: 100 ohms Range: -40 to 135°C, (-40 to 275°F) Accuracy: $\pm 1.0^\circ\text{C}$ , $\pm 1.8^\circ\text{F}$ Resolution: 0.1°C to 0.18°F (10k ohms to 100k ohms supported using translation table) Potentiometer: Translation table configurable on several points, Accuracy: $\pm 0.5\%$ Accuracy $\pm 0.3\%$ full scale Input Resolution: 16-bit analog/digital converter
<b>Outputs</b>	Quantity: 12 (software configurable); Hands-Off-Auto (HOA) Switches Analog 0 to 10 VDC, digital 0 to 12 VDC (on/off) or PWM PWM output: adjustable period from 2 seconds to 15 minutes 60 mA maximum @ 12 VDC (60°C; 140°F) maximum load 200 ohms Auto-reset fuse: 60 mA @ 60°C; 140°F, 100mA @ 20°C; 68°F Output Resolution: 10-bit digital/analog converter

**LN-PRG510-1 and LN-PRG500-1 Controllers (Part 1 of 2)**

<b>Product Codes</b>	LN-PRG510-1 and LN-PRG500-1
<b>Power Requirement</b>	Voltage: 24 VAC/DC; +/- 15%, 50/60 Hz, Class 2 Protection: 2.5 A removable fuse for triac when using the internal power supply Consumption: 5 VA Maximum Consumption: 18 VA Power Supply: 15 VDC output used to power 4 to 20 mA inputs
<b>Ambient Storage Conditions</b>	Ambient Operating Temperature: 0 to 70°C, (32 to 158°F) Ambient Storage Temperature: -20 to 70°C, (-4 to 158°F) Ambient Relative Humidity: 0 to 90% noncondensing



## LN-PRG510-1 and LN-PRG500-1 Controllers (Part 2 of 2)

<b>General</b>	Standard: LONMARK Functional Profile: SCC-VAV Controller #8502 Processor: Neuron 3150, 8 bits, 10 MHz Memory: Nonvolatile Flash 64k (APB application), Nonvolatile Flash 64k (storage) Media Channel: TP/FT-10; 78 Kbps Communication: LonTalk protocol Transceiver: FTX-1
<b>Enclosure</b>	Material: LEXAN® 500R (GE) Dimensions (with screws): 3.74 x 7.68 x 2.82 in. (95 x 195 x 72 mm) Shipping Weight: 1.76 lb (0.80 kg)
<b>Agency</b>	UL Listed: UL916 Energy management equipment Material: UL94-5VA
<b>Electromagnetic Compatibility</b>	CE Emission: EN55022: 1998 class B (conducted and radiated) CE Immunity: EN61000-4-2:1995, level 3 in air EN61000-4-2: 1995, level 2 by contact EN61000-4-3: 1996, level 2 EN61000-4-4: 1995, level 2 EN61000-4-6: 1996, level 2 ENV 50204: 1995, level 2
<b>Inputs</b>	Quantity: 12 universal software configurable Input Types: Digital: Dry Contact Pulse: Dry Contact Analog Voltage: 0 to 10 VDC, Accuracy: ±0.5%, Analog current: 4 to 20 mA with 249 ohms external resistor (wired in parallel), Accuracy: ±0.5% Resistor Support: Thermistor: Type 2, Type 3 10k ohms Range: -40 to 150°C, (-40 to 302°F) Accuracy: ±0.5°C, ±0.9°F Platinum: RTD 1k ohm Range: -40 to 150°C, (-40 to 302°F) Accuracy: ±1.0°C, ±1.8°F, PT100: 100 ohms Range: -40 to 135°C, (-40 to 275°F) Accuracy: ±1.0°C, ±1.8°F Resolution: 0.1°C to 0.18°F (10k ohms to 100k ohms supported using translation table) Potentiometer: Translation table configurable on several points, Accuracy: ±0.5% Accuracy ±0.3% full scale Input Resolution: 16-bit analog/digital converter
<b>Outputs</b>	Quantity: 12 (software configurable); HOA Switches Analog 0 to 10 VDC, digital 0 to 12 VDC (on/off) or PWM PWM output: adjustable period from 2 seconds to 15 minutes 60 mA maximum @ 12 VDC (60°C; 140°F) maximum load 200 ohms Auto-reset fuse: 60 mA @ 60°C; 140°F, 100 mA @ 20°C; 68°F Output Resolution: 10-bit digital/analog converter

*The performance specifications are nominal and conform to acceptable industry standard. For application at conditions beyond these specifications, consult the local Johnson Controls® office. Johnson Controls, Inc. shall not be liable for damages resulting from misapplication or misuse of its products.*

## North American Emissions Compliance

### ***United States***

This equipment has been tested and found to comply with the limits for a Class A digital device pursuant to Part 15 of the FCC Rules. These limits are designed to provide reasonable protection against harmful interference when this equipment is operated in a commercial environment. This equipment generates, uses, and can radiate radio frequency energy and, if not installed and used in accordance with the instruction manual, may cause harmful interference to radio communications. Operation of this equipment in a residential area is likely to cause harmful interference, in which case the user will be required to correct the interference at his/her own expense.

### ***Canada***

This Class (A) digital apparatus meets all the requirements of the Canadian Interference-Causing Equipment Regulations. Cet appareil numérique de la Classe (A) respecte toutes les exigences du Règlement sur le matériel brouilleur du Canada.



**Building Efficiency**

507 E. Michigan Street, Milwaukee, WI 53202

*Metasys® and Johnson Controls® are registered trademarks of Johnson Controls, Inc.  
All other marks herein are the marks of their respective owners. © 2008 Johnson Controls, Inc.*

# LX Series Free Programmable Controllers

## Product Bulletin

LX-PRG203-1, LX-PRG300-1, LX-PRG4x0-1, LX-PRG5x0-1

Code No. LIT-12011492

Issued June 22, 2009

The LX Series Free Programmable Controllers are microprocessor-based free programmable controllers, designed to control various Heating, Ventilating, and Air Conditioning (HVAC) applications.

The LX Series Free Programmable controllers product family is built to meet rigorous quality standards. The complete family of LX Series controllers are designed for use with any LONWORKS® network open and interoperable system.



Figure 1: LX-PRG510-1 Controller

Table 1: Features and Benefits

Features	Benefits
<b>Configurable Software</b>	Features FX Workbench compatible wizards that provide the ability to easily configure inputs, outputs, and sequence options. LONMARK® certified according to the Interoperability Guidelines Version 3.4. Also features more than 60 network variables.
<b>Robust Hardware</b>	Features a fire retardant plastic enclosure, a 128k Flash memory for the configuration and trending of up to 12,000 events, and a status indicator on each output.
<b>Powerful Control Options</b>	Allow you to easily configure all features including, input types, output types, heating and cooling stages, variable airflow, and Proportional plus Integral plus Derivative (PID) loops. The controller supports four input types: space temperature; setpoint adjustment; duct temperature; and occupancy bypass, or window contacts.

## LX Series Free Programmable Controllers Overview

You can control equipment, such as roof top units, fan coils, heat pumps, ventilator units, and terminal units, with the LX Series Free Programmable Controllers (Figure 1). The LX Series Free Programmable Controller line can be programmed using the LX-Free Programming Wizard or the LX Graphical Programming Interface (GPI) Wizard with Facility Explorer (FX) Workbench software.

### LX-Free Programming Wizard

The LX-Free Programming Wizard tool is unique in the controls industry because it combines a user-friendly Graphical User Interface (GUI) with the power and flexibility of a code editor and compiler. The LX-Free Programming Wizard tool uses a simplified version of Beginner's All purpose Symbolic Instruction Code (BASIC) that is custom made to suit control requirements.

### LX Graphical Programming Interface (GPI) Wizard

The LX Graphical Programming Interface Wizard tool is a programming tool enabling the building of control sequences by dragging and dropping block objects and then linking the objects with a simple click, select, and release. With a user-friendly interface and intuitive programming environment, GPI makes Heating, Ventilating, and Air Conditioning (HVAC) programming easier than ever.

### LX-Scheduler Wizard

The LX-Scheduler Wizard allows you to easily configure a weekly-based schedule and a special day schedule for holidays. Easily add and remove the special day event into the calendar by a simple click of the mouse.

### Dimensions

Figure 2 shows the dimensions for the LX-PRG203-1 and LX-PRG300-1 controllers.

Figure 3 shows the dimensions for the LX-PRG4x0-1 and LX-PRG5x1-0 controllers.

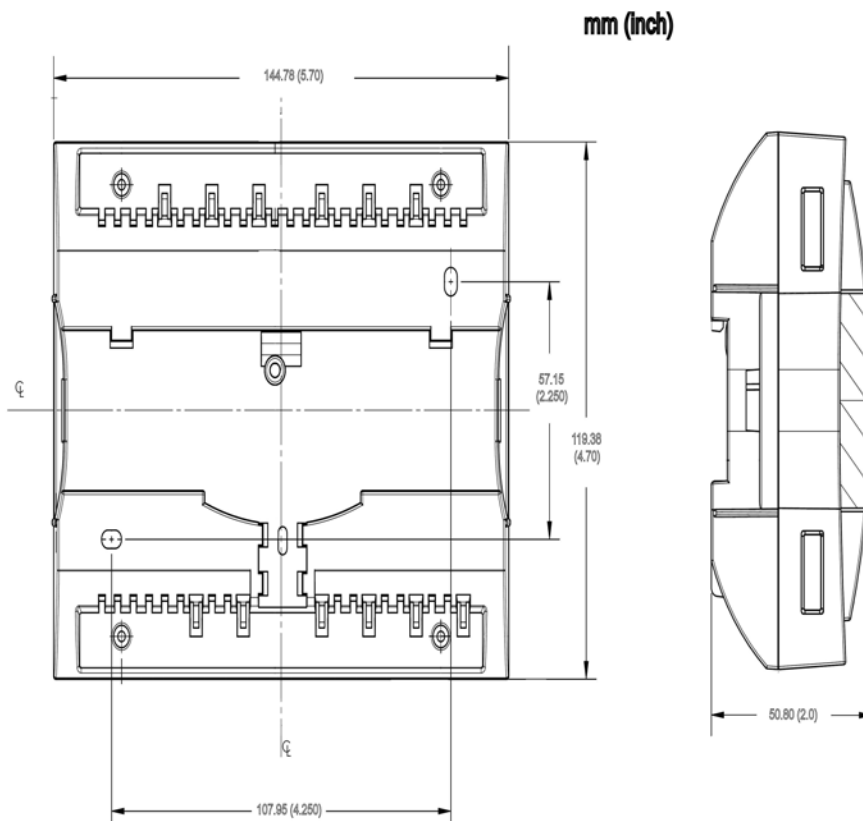
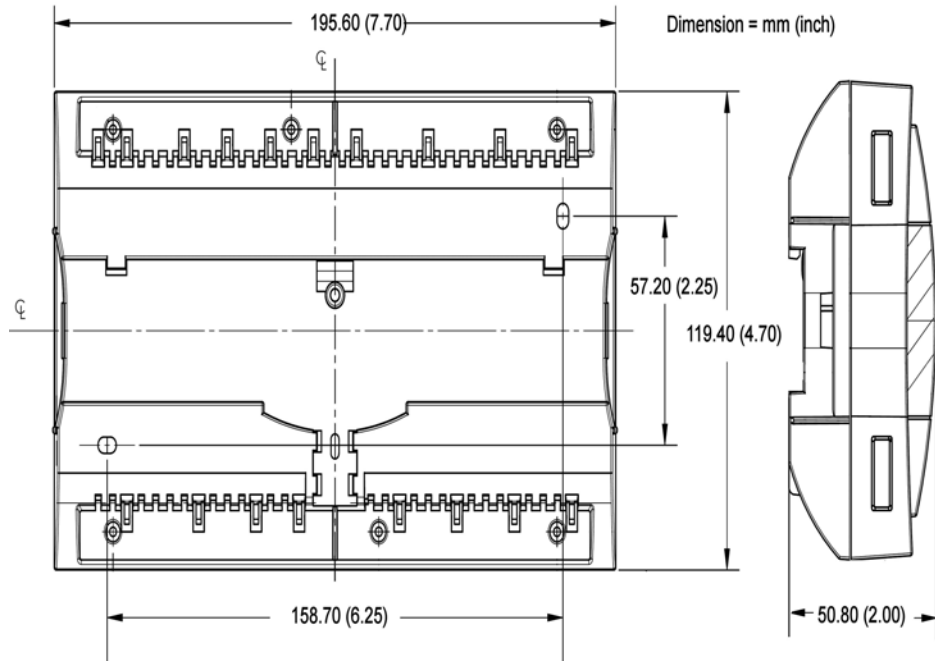

Figure 2: LX-PRG203-1 and LX-PRG300-1 Dimensions



**Figure 3: LX-PRG4x0-1 and LX-PRG5x0-1 Dimensions**

### Selection Chart

**Table 2: LX Series Programmable Controllers Selection Chart**

Code Number	Description
<b>LX-PRG203-1</b>	LONMARK certified Programmable Controller with 6 Universal Input (UI), 5 Digital Output (DO), 3 Universal Output (UO), and LNS plug-in, 24 VAC.
<b>LX-PRG300-1</b>	LONMARK certified Programmable Controller with 10 UI, 10 UO, and LNS plug-in, 24 VAC
<b>LX-PRG400-1</b>	LONMARK certified Programmable Controller with 12 UI, 12 UO, and LNS plug-in, 24 VAC
<b>LX-PRG410-1</b>	LONMARK certified Programmable Controller with 12 UI, 12 UO, Hands-Off-Auto (HOA) Switches, and LNS plug-in, 24 VAC
<b>LX-PRG500-1</b>	LONMARK certified Programmable Controller with 16 UI, 12 UO, and LNS plug-in, 24 VAC
<b>LX-PRG510-1</b>	LONMARK certified Programmable Controller with 16 UI, 12 UO, HOA Switches, and LNS plug-in, 24 VAC

### Repair Information

If the LX Series Free Programmable controllers fail to operate within their specifications, replace the unit. For a replacement, contact the nearest Johnson Controls® representative.

# LONMARK Objects and Network Variables

## LX-Free Programming Wizard

The following figures show the LONMARK Objects and Network Variables for the LX Free Programmable Controllers when you use the LX-Free Programming Wizard.

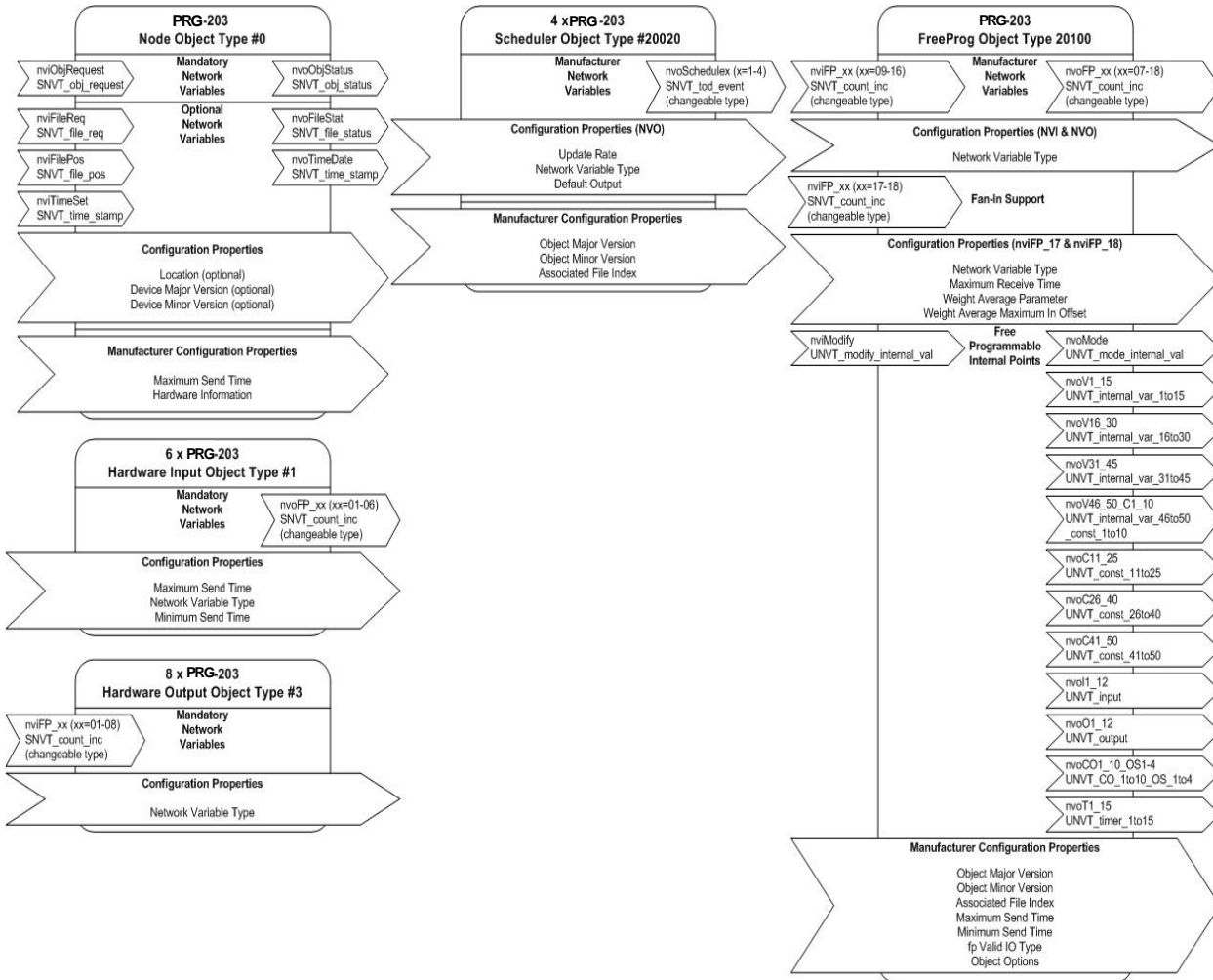

Figure 4: LX-Free Programming Wizard LONMARK Objects and Network Variables - LX-PRG203-1

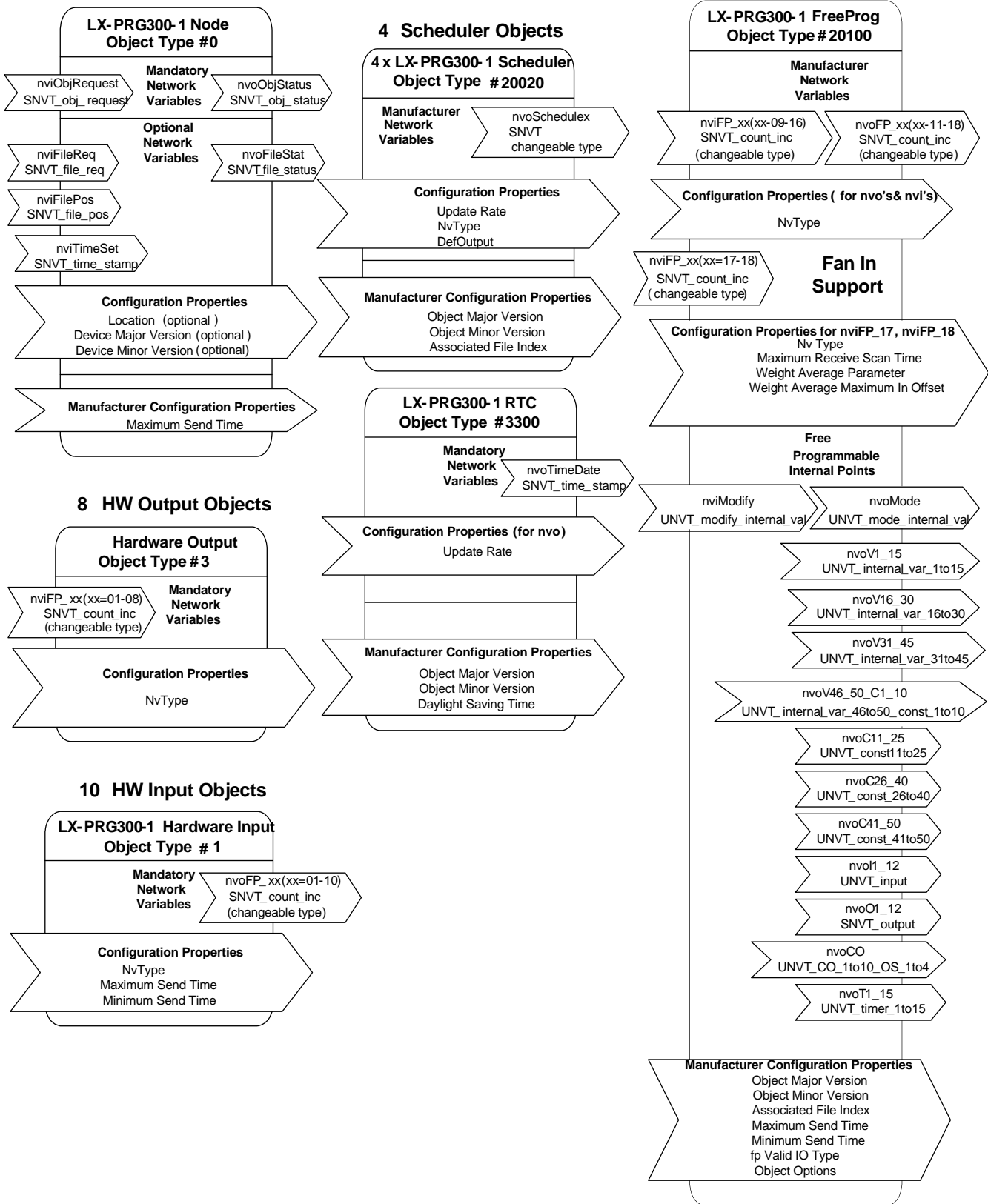

Figure 5: LX-Free Programming Wizard LONMARK Objects and Network Variables - LX-PRG300-1

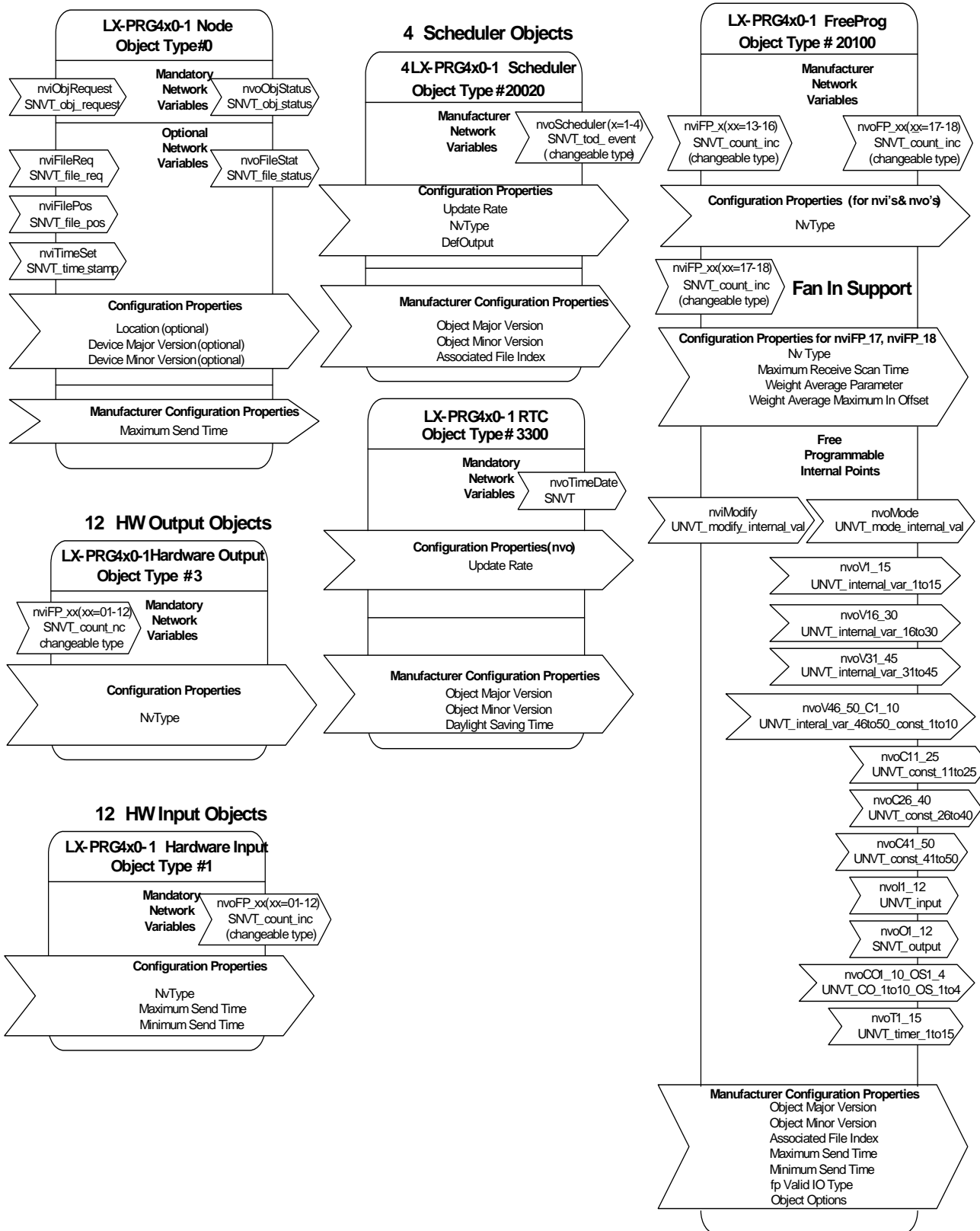

Figure 6: LX-Free Programming Wizard LONMARK Objects and Network Variables - LX-PRG4x0-1



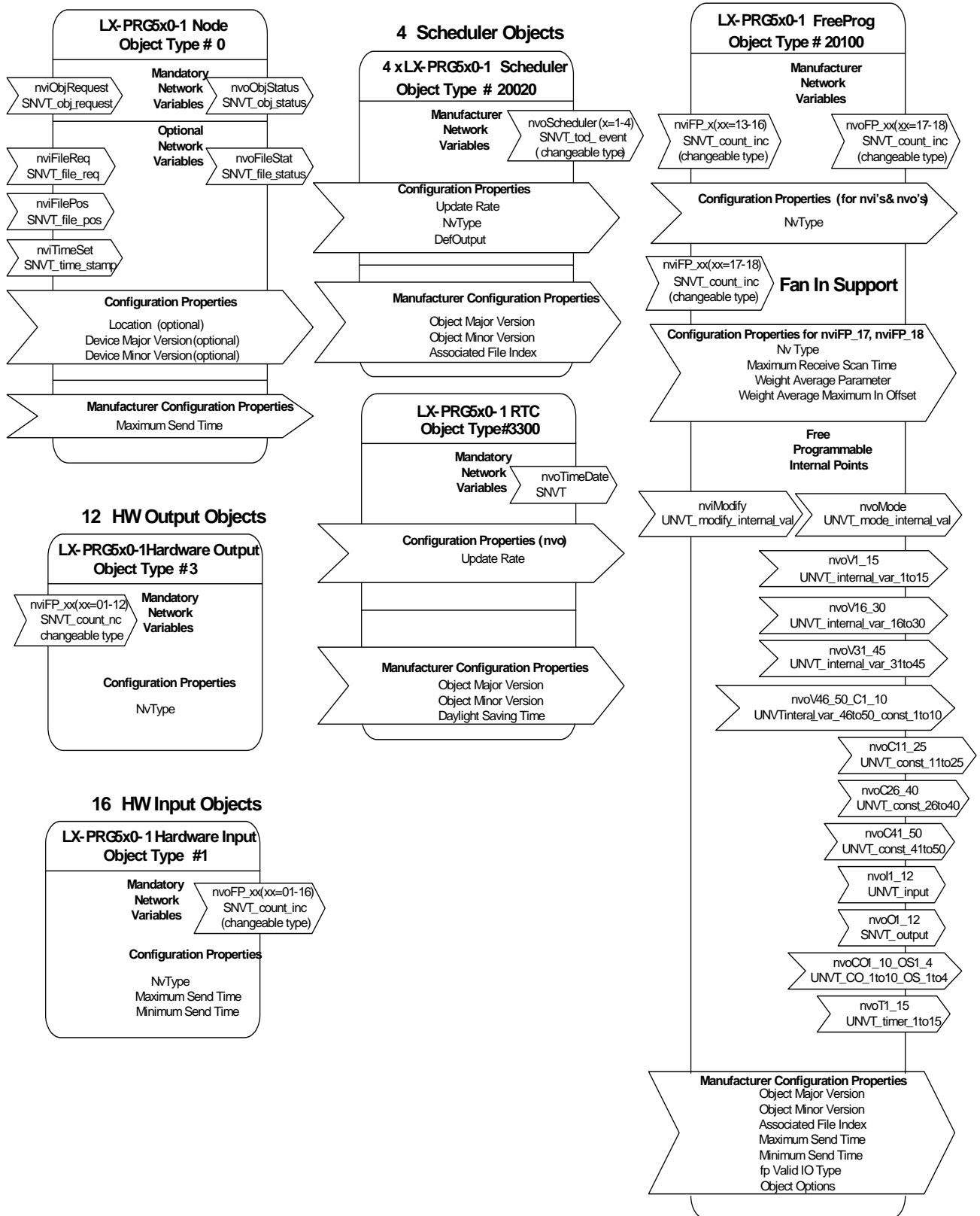

Figure 7: LX-Free Programming Wizard LonMark Objects and Network Variables - LX-PRG5x0-1

# LX GPI

The following figures show the LONMARK Objects and Network Variables for the LX Free Programmable Controllers when you use GPI.

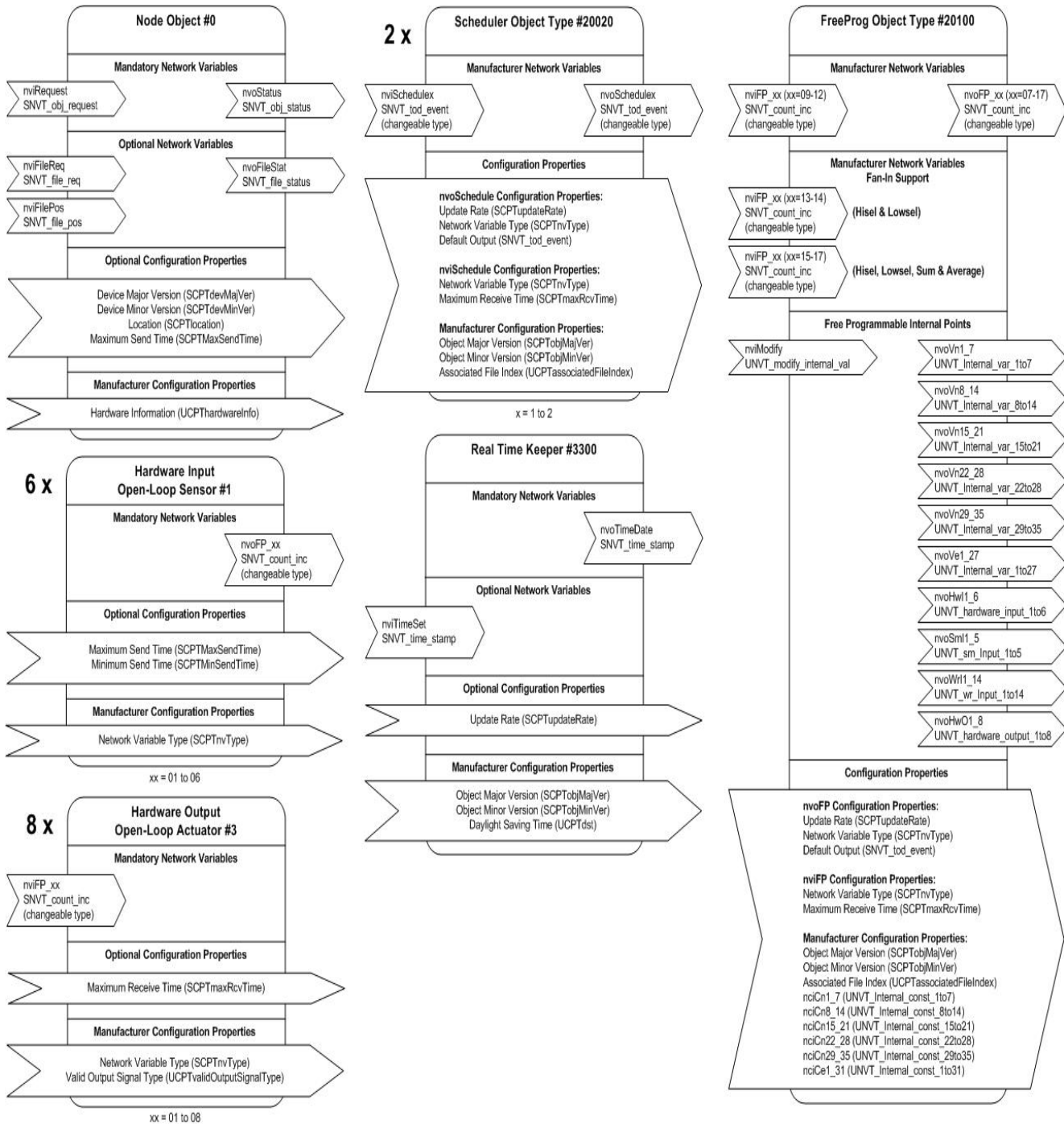

Figure 8: GPI LONMARK Objects and Network Variables - LX-PRG203-1

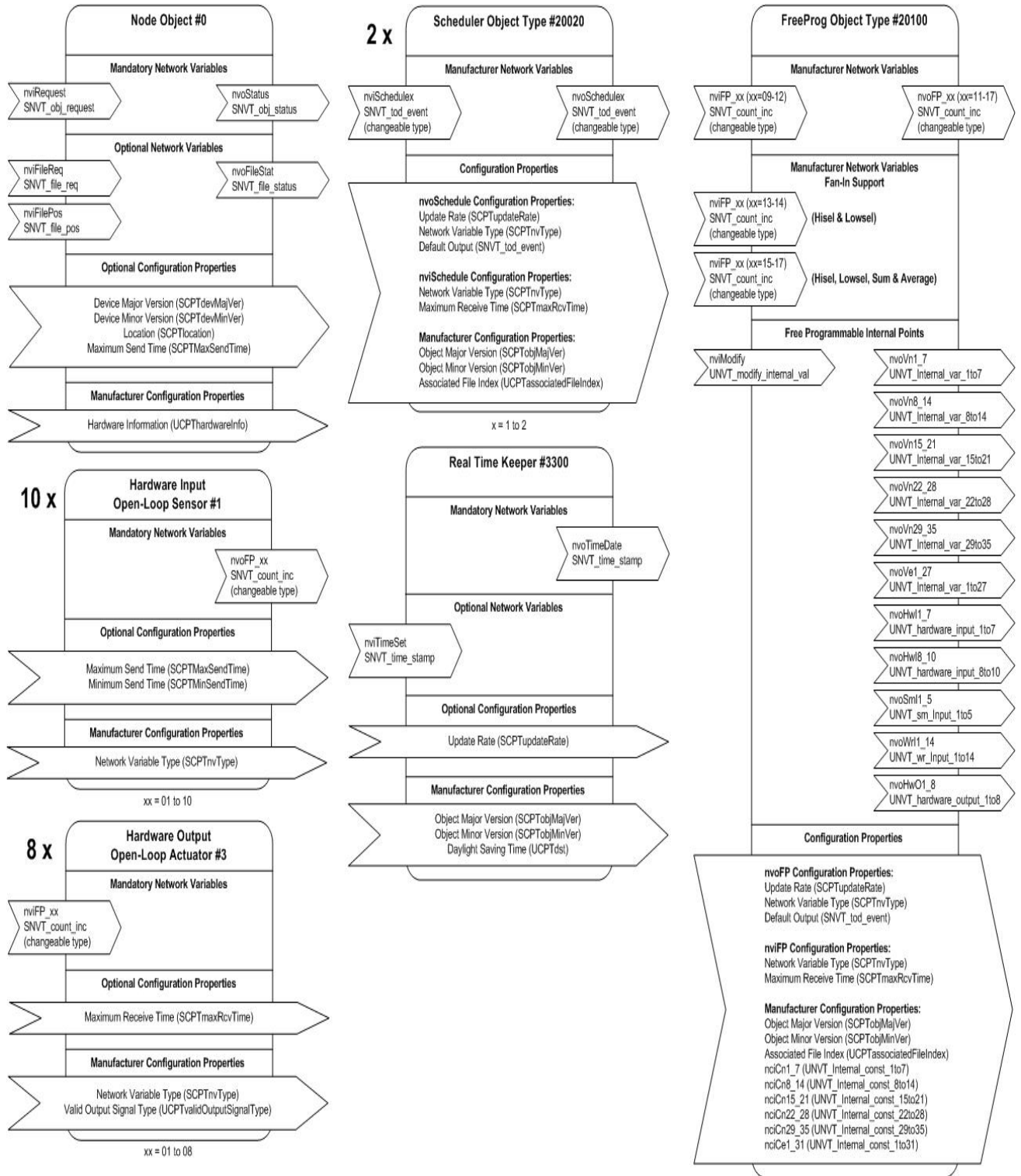
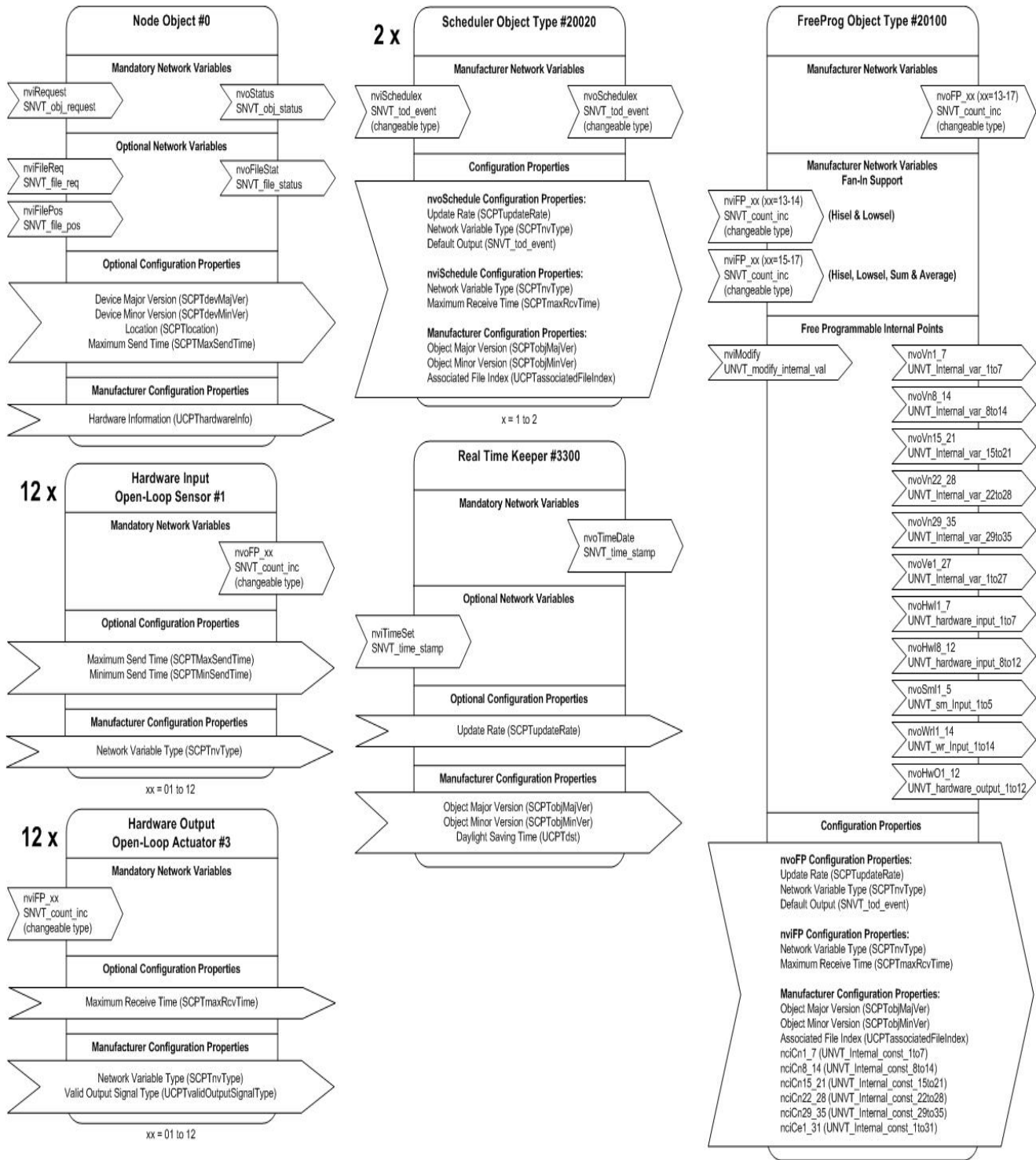

Figure 9: GPI LONMARK Objects and Network Variables - LX-PRG300-1



**Figure 10: GPI LONMARK Objects and Network Variables - LX-PRG4x0-1**

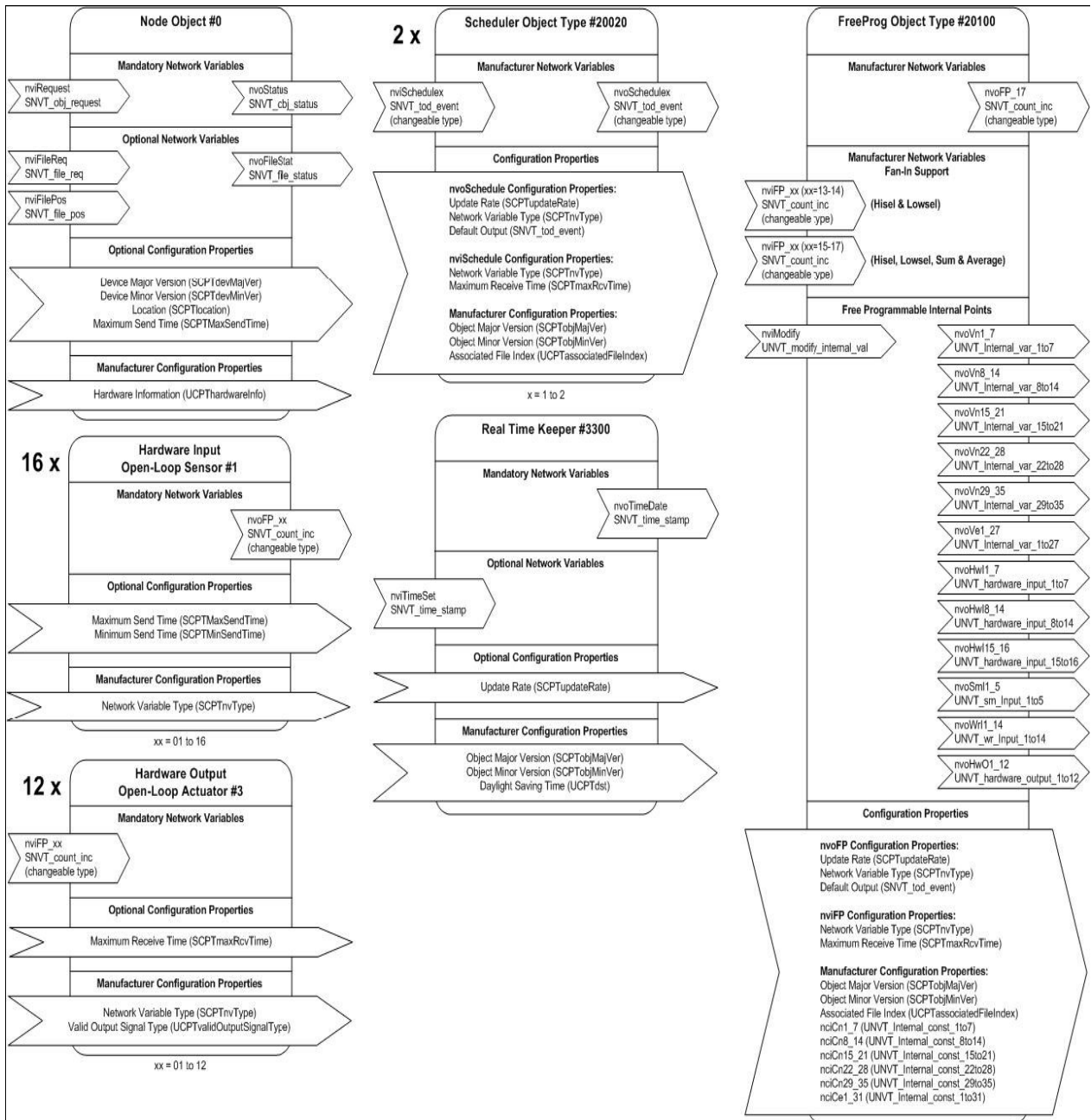

Figure 11: GPI LONMARK Objects and Network Variables - LX-PRG5x0-1

## Technical Specifications

### LX-PRG203-1 (Part 1 of 2)

<b>Product Code</b>	LX-PRG203-1
<b>Power Requirement</b>	Voltage: 24 VAC/DC; $\pm 15\%$ , 50/60 Hz, Class 2 Protection: 1.85 A auto-reset fuse Consumption: 5 VA Maximum Consumption: 18 VA
<b>Ambient Conditions</b>	Ambient Operating Temperature: 0 to 70°C, (32 to 158°F) Ambient Storage Temperature: -20 to 70°C, (-4 to 158°F) Ambient Relative Humidity: 0 to 90% noncondensing
<b>General</b>	LONMARK certified according to the Interoperability Guidelines Version 3.4 Processor: Neuron® 3150®, 8 bits, 10 MHz Memory: Nonvolatile Flash 64k (APB application); Non-volatile Flash 128K (storage) Media Channel: TP/FT-10; 78 Kbps Communication: LonTalk® protocol Status Indicator: Green LED - power status and LON TX, Orange LED - service and LON RX Communication Jack: LON audio jack mono 1/8 in (3.5 mm)
<b>Enclosure</b>	Material: ABS type PA-765A Dimensions (with screws): 5.7 x 4.7 x 2.0 in. (144.8 x 119.4 x 50.8 mm) Shipping Weight: 0.97 lb (0.44 kg)
<b>Electromagnetic Compatibility</b>	CE Emission: EN55022: 1998 class B (conducted and radiated) CE Immunity: EN61000-4-2:1995, level 3 in air EN61000-4-2: 1995, level 2 by contact EN61000-4-3: 1996, level 2 EN61000-4-4: 1995, level 2 EN61000-4-6: 1996, level 2 ENV 50204: 1995, level 2
<b>Agency</b>	UL Listed: UL916 Energy management equipment Material: UL94-5VA
<b>Inputs</b>	Quantity: 6 universal software configurable Input Types: Digital: Dry Contact Pulse: Dry Contact Voltage: 0 to 10 VDC, Current: 0 to 20 mA with 249 ohm external resistor (wired in parallel), Accuracy: $\pm 0.5\%$ Resistor Support: Thermistor: Type 2 and Type 3 10k ohm Range: -40 to 150°C, (-40 to 302°F) Platinum: PT1000 1k ohm Range: -40 to 150°C, (-40 to 302°F) PT100: 100 ohm Range: -40 to 135°C, (-40 to 275°F) Potentiometer: Translation table configurable on several points, Accuracy: $\pm 0.5\%$ Input Resolution: 16-bit analog/digital converter

**LX-PRG203-1 (Part 2 of 2)**

<b>Outputs</b>	<p>Quantity: 8</p> <p>5 Digital: 24 VAC Triac, digital (on/off) or PWM 0.75 A at 70°C; 158°F 1 A at 40°C; 104°F PWM control: adjustable period from 2 seconds to 15 minutes</p> <p>3 Universal: 0-10 VDC, digital 0-12 VDC (on/off) or PWM PWM control: adjustable period from 2 seconds to 15 minutes 20 mA maximum at 12 VDC (60°C; 140°F) Auto reset fuse Maximum load 600 ohm Output Resolution: 10-bit digital/analog converter</p>
----------------	--

**LX-PRG300-1 (Part 1 of 2)**

<b>Product Code</b>	LX-PRG300-1
<b>Power Requirement</b>	<p>Voltage: 24 VAC/DC; ±15%, 50/60 Hz, Class 2</p> <p>Protection: 1.85 A auto-reset fuse</p> <p>Consumption: 5 VA</p> <p>Maximum Consumption: 18 VA</p>
<b>Ambient Conditions</b>	<p>Ambient Operating Temperature: 0 to 70°C, (32 to 158°F)</p> <p>Ambient Storage Temperature: -20 to 70°C, (-4 to 158°F)</p> <p>Ambient Relative Humidity: 0 to 90% noncondensing</p>
<b>General</b>	<p>LONMARK certified according to the Interoperability Guidelines Version 3.4 Processor: Neuron 3150, 8 bits, 10 MHz</p> <p>Memory: Nonvolatile Flash 64k (APB application), Nonvolatile Flash 128k (storage)</p> <p>Media Channel: TP/FT-10; 78 Kbps</p> <p>Communication: LonTalk protocol</p> <p>Clock: Real-time clock chip, CR2032 lithium battery (for clock)</p> <p>Status Indicator: Green LED - power status and LON TX, Orange LED - service and LON RX</p> <p>Communication Jack: LON audio jack mono 1/8 in (3.5 mm)</p>
<b>Enclosure</b>	<p>Material: ABS type PA-765-A</p> <p>Dimensions: 5.7 x 4.7 x 2.0 in. (144.8 x 119.4 x 50.8 mm)</p> <p>Shipping Weight: 0.86 lb (0.39 kg)</p>
<b>Agency</b>	<p>UL Listed: UL916 Energy management equipment</p> <p>Material: UL94-5VA</p>
<b>Electromagnetic Compatibility</b>	<p>CE Emission: EN55022: 1998 class B (conducted and radiated)</p> <p>CE Immunity: EN61000-4-2:1995, level 3 in air EN61000-4-2: 1995, level 2 by contact EN61000-4-3: 1996, level 2 EN61000-4-4: 1995, level 2 EN61000-4-6: 1996, level 2 ENV 50204: 1995, level 2</p>

### LX-PRG300-1 (Part 2 of 2)

<b>Inputs</b>	<p>Quantity: 10 universal software configurable</p> <p>Input Types:</p> <ul style="list-style-type: none"> <li>Digital: Dry Contact</li> <li>Pulse: Dry Contact</li> </ul> <p>Analog Voltage: 0 to 10 VDC, Accuracy: <math>\pm 0.5\%</math>,</p> <p>Analog current: 4 to 20 mA with 249 ohm external resistor (wired in parallel), Accuracy: <math>\pm 0.5\%</math></p> <p>Resistor Support:</p> <ul style="list-style-type: none"> <li>Thermistor: Type 2, Type 3 10k ohm <ul style="list-style-type: none"> <li>Range: -40 to 150°C, (-40 to 302°F)</li> <li>Accuracy: <math>\pm 0.5^\circ\text{C}</math>, <math>\pm 0.9^\circ\text{F}</math></li> </ul> </li> <li>Platinum: RTD 1k ohm <ul style="list-style-type: none"> <li>Range: -40 to 150°C, (-40 to 302°F)</li> <li>Accuracy: <math>\pm 1.0^\circ\text{C}</math>, <math>\pm 1.8^\circ\text{F}</math>,</li> </ul> </li> <li>PT100: 100 ohm <ul style="list-style-type: none"> <li>Range: -40 to 135°C, (-40 to 275°F)</li> <li>Accuracy: <math>\pm 1.0^\circ\text{C}</math>, <math>\pm 1.8^\circ\text{F}</math></li> </ul> </li> </ul> <p>Resolution: 0.1°C to 0.18°F (10k ohm to 100k ohm supported using translation table)</p> <p>Potentiometer:</p> <ul style="list-style-type: none"> <li>Translation table configurable on several points, Accuracy: <math>\pm 0.5\%</math></li> </ul> <p>Accuracy <math>\pm 0.3\%</math> full scale</p> <p>Input Resolution: 16-bit analog/digital converter</p>
<b>Outputs</b>	<p>Quantity: 8 (software configurable)</p> <p>0 to 10 VDC, digital 0 to 12 VDC (on/off) or PWM</p> <ul style="list-style-type: none"> <li>PWM output: adjustable period from 2 seconds to 15 minutes</li> <li>60 mA maximum at 12 VDC (60°C; 140°F)</li> <li>maximum load 200 ohm</li> </ul> <p>Auto-reset fuse: 60 mA at 60°C; 140°F, 100 mA at 20°C; 68°F</p> <p>Output Resolution: 10-bit digital/analog converter</p>

### LX-PRG410-1 and LX-PRG400-1 (Part 1 of 2)

<b>Product Codes</b>	LX-PRG410-1 and LX-PRG400-1
<b>Power Requirement</b>	<p>Voltage: 24 VAC/DC; <math>\pm 15\%</math>, 50/60 Hz, Class 2</p> <p>Protection: 2.5 A auto-reset fuse</p> <p>Consumption: 5 VA</p> <p>Maximum Consumption: 18 VA</p> <p>Power Supply: 15 VDC output used to power 4 to 20 mA inputs</p>
<b>Ambient Conditions</b>	<p>Ambient Operating Temperature: 0 to 70°C, (32 to 158°F)</p> <p>Ambient Storage Temperature: -20 to 70°C, (-4 to 158°F)</p> <p>Ambient Relative Humidity: 0 to 90% noncondensing</p>
<b>General</b>	<p>LONMARK certified according to the Interoperability Guidelines Version 3.4</p> <p>Processor: Neuron 3150, 8 bits, 10 MHz</p> <p>Memory: Nonvolatile Flash 64k (APB application), Nonvolatile Flash 128k (storage)</p> <p>Media Channel: TP/FT-10; 78 Kbps</p> <p>Communication: LonTalk protocol</p> <p>Clock: Real-time clock chip, CR2032 lithium battery (for clock)</p> <p>Status Indicator: Green LED - power status and LON TX, Orange LED - service and LON RX</p> <p>Communication Jack: LON audio jack mono 1/8 in (3.5 mm)</p>
<b>Enclosure</b>	<p>Material: ABS type PA-765A</p> <p>Dimensions (with screws): 7.7 x 4.7 x 2.0 in. (195.6 x 119.4 x 50.8 mm)</p> <p>Shipping Weight: 0.86 lb (0.39 kg)</p>



### LX-PRG410-1 and LX-PRG400-1 (Part 2 of 2)

<b>Agency</b>	UL Listed: UL916 Energy management equipment Material: UL94-5VA
<b>Electromagnetic Compatibility</b>	CE Emission EN55022: 1998 class B (conducted and radiated) CE Immunity: EN61000-4-2:1995, level 3 in air EN61000-4-2: 1995, level 2 by contact EN61000-4-3: 1996, level 2 EN61000-4-4: 1995, level 2 EN61000-4-6: 1996, level 2 ENV 50204: 1995, level 2
<b>Inputs</b>	Quantity: 12 universal software configurable Input Types: Digital: Dry Contact Pulse: Dry Contact Analog Voltage: 0 to 10 VDC, Accuracy: $\pm 0.5\%$ , Analog current: 4 to 20 mA with 249 ohm external resistor (wired in parallel), Accuracy: $\pm 0.5\%$ Resistor Support: Thermistor: Type 2, Type 3 10k ohm Range: -40 to 150°C, (-40 to 302°F) Accuracy: $\pm 0.5^\circ\text{C}$ , $\pm 0.9^\circ\text{F}$ Platinum: RTD 1k ohm Range: -40 to 150°C, (-40 to 302°F) Accuracy: $\pm 1.0^\circ\text{C}$ , $\pm 1.8^\circ\text{F}$ , PT100: 100 ohm Range: -40 to 135°C, (-40 to 275°F) Accuracy: $\pm 1.0^\circ\text{C}$ , $\pm 1.8^\circ\text{F}$ Resolution: 0.1°C to 0.18°F (10k ohm to 100k ohm supported using translation table) Potentiometer: Translation table configurable on several points, Accuracy: $\pm 0.5\%$ Accuracy $\pm 0.3\%$ full scale Input Resolution: 16-bit analog/digital converter
<b>Outputs</b>	Quantity: 12 (software configurable) Analog 0 to 10 VDC, digital 0 to 12 VDC (on/off) or PWM PWM output: adjustable period from 2 seconds to 15 minutes 60 mA maximum at 12 VDC (60°C; 140°F) maximum load 200 ohm Auto-reset fuse: 60 mA at 60°C; 140°F, 100 mA at 20°C; 68°F Output Resolution: 10-bit digital/analog converter

### LX-PRG510-1 and LX-PRG500-1 Controllers (Part 1 of 2)

<b>Product Codes</b>	LX-PRG510-1 and LX-PRG500-1
<b>Power Requirement</b>	Voltage: 24 VAC/DC; $\pm 15\%$ , 50/60 Hz, Class 2 Protection: 2.5 A removable fuse for triac when using the internal power supply Consumption: 5 VA Maximum Consumption: 18 VA Power Supply: 15 VDC output used to power 4 to 20 mA inputs
<b>Ambient Conditions</b>	Ambient Operating Temperature: 0 to 70°C, (32 to 158°F) Ambient Storage Temperature: -20 to 70°C, (-4 to 158°F) Ambient Relative Humidity: 0 to 90% noncondensing

## LX-PRG510-1 and LX-PRG500-1 Controllers (Part 2 of 2)

<b>General</b>	LONMARK certified according to the Interoperability Guidelines Version 3.4 Processor: Neuron 3150, 8 bits, 10 MHz Memory: Nonvolatile Flash 64k (APB application), Nonvolatile Flash 64k (storage) Media Channel: TP/FT-10; 78 Kbps Communication: LonTalk protocol Transceiver: FTX-1
<b>Enclosure</b>	Material: LEXAN® 500R (GE) Dimensions (with screws): 3.74 x 7.68 x 2.82 in. (95 x 195 x 72 mm) Shipping Weight: 1.76 lb (0.80 kg)
<b>Agency</b>	UL Listed: UL916 Energy management equipment Material: UL94-5VA
<b>Electromagnetic Compatibility</b>	CE Emission: EN55022: 1998 class B (conducted and radiated) CE Immunity: EN61000-4-2:1995, level 3 in air EN61000-4-2: 1995, level 2 by contact EN61000-4-3: 1996, level 2 EN61000-4-4: 1995, level 2 EN61000-4-6: 1996, level 2 ENV 50204: 1995, level 2
<b>Inputs</b>	Quantity: 12 universal software configurable Input Types: Digital: Dry Contact Pulse: Dry Contact Analog Voltage: 0 to 10 VDC, Accuracy: ±0.5%, Analog current: 4 to 20 mA with 249 ohm external resistor (wired in parallel), Accuracy: ±0.5% Resistor Support: Thermistor: Type 2, Type 3 10k ohm Range: -40 to 150°C, (-40 to 302°F) Accuracy: ±0.5°C, ±0.9°F Platinum: RTD 1k ohm Range: -40 to 150°C, (-40 to 302°F) Accuracy: ±1.0°C, ±1.8°F, PT100: 100 ohm Range: -40 to 135°C, (-40 to 275°F) Accuracy: ±1.0°C, ±1.8°F Resolution: 0.1°C to 0.18°F (10k ohm to 100 K ohm supported using translation table) Potentiometer: Translation table configurable on several points, Accuracy: ±0.5% Accuracy ±0.3% full scale Input Resolution: 16-bit analog/digital converter
<b>Outputs</b>	Quantity: 12 (software configurable) Analog 0 to 10 VDC, digital 0 to 12 VDC (on/off) or PWM PWM output: adjustable period from 2 seconds to 15 minutes 60 mA maximum at 12 VDC (60°C; 140°F) maximum load 200 ohm Auto-reset fuse: 60 mA at 60°C; 140°F, 100 mA at 20°C; 68°F Output Resolution: 10-bit digital/analog converter

*The performance specifications are nominal and conform to acceptable industry standard. For application at conditions beyond these specifications, consult the local Johnson Controls® office. Johnson Controls, Inc. shall not be liable for damages resulting from misapplication or misuse of its products.*

## North American Emissions Compliance

### **United States Emissions Compliance**

#### **Compliance Statement (Part 15.19)**

*This device complies with Part 15 of the FCC Rules. Operation is subject to the following two conditions:*

- 1. This device may not cause harmful interference, and*
- 2. This device must accept any interference received, including interference that may cause undesired operation.*

#### **Warning (Part 15.21)**

*Changes or modifications not expressly approved by the party responsible for compliance could void the user's authority to operate the equipment.*

### **Canadian Emissions Compliance**

#### **Industry Canada Statement**

*The term **IC** before the certification/registration number only signifies that the Industry Canada technical specifications were met.*

*Le terme « IC » précédant le numéro d'accréditation/inscription signifie simplement que le produit est conforme aux spécifications techniques d'Industry Canada.*



**Building Efficiency**  
507 E. Michigan Street, Milwaukee, WI 53202

*Johnson Controls® is registered trademark of Johnson Controls, Inc.  
All other marks herein are the marks of their respective owners. © 2009 Johnson Controls, Inc.*